

Partiwall®

SEPARATING WALLS FOR CLASS 1a BUILDINGS TIMBER FRAMED

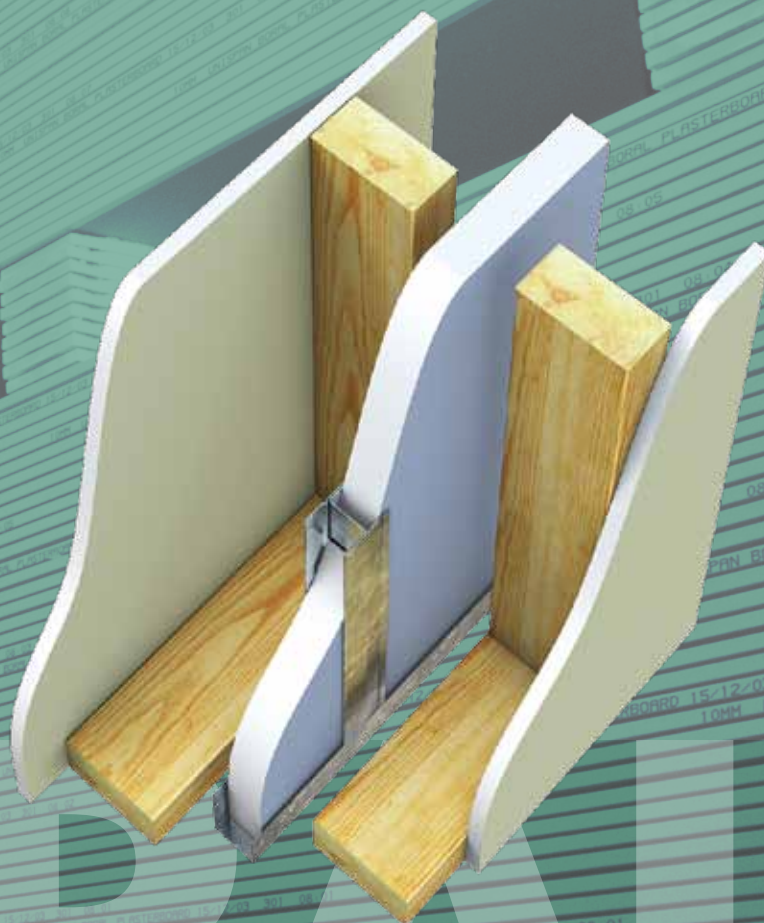

Boral's Purpose ...

to create sustainable solutions for a worldwide building and construction industry.

Boral is a leading Australian supplier of building and construction materials, operating also throughout Asia and in the United States.

Boral offers a wide range of building solutions for the residential, commercial and infrastructure sectors, including Bricks, Roof Tiles, Plasterboard, Concrete, Asphalt and many others. Information on the full range of Boral products can be found at www.boral.com.au

Boral Plasterboard specialises in the manufacture, distribution and installation of plasterboard based wall and ceiling systems. In Australia, Boral operates plasterboard manufacturing facilities in New South Wales, Queensland and Victoria. Boral Plasterboard also operates Australia-wide distribution network of company owned stores and independent resellers.

Striving to create sustainable building solutions for a worldwide building and construction industry, Boral aims to reduce the impact of its operations on the environment and to make a positive difference to the communities in which it operates.

Boral Plasterboard prides itself on its leadership in the area of lightweight building solutions.

Among the successful solutions introduced by the company over the years are: Partiwall® and InRWall® separating wall systems, OutRWall® and FireClad® fire rated exterior wall systems, CinemaZone® acoustic walls and ceilings for home cinemas, and many others.

Boral Plasterboard's Product and Systems Development (PSD) team boasts expertise in lightweight fire rated and acoustic systems, and routinely works with customers to select and, if required, tailor solutions for specific projects.

Together with the TecASSIST® customer help line, Boral Plasterboard's PSD team is well positioned to provide technical support to projects of any size and complexity.

For expert advice on lightweight Building Systems, contact Boral TecASSIST® 1800 811 222.



The new Gypsum receiving/conveying system over Lorimer Street, Port Melbourne.

Contents

Introduction	4	Pitched Roof - Wall/Roof Junction Detail (PW13)	16
What is Partiwall®	5	Flat Roof - Wall/Roof Junction Detail (PW14)	16
Features and Benefits	5	Roof Parapet - Junction Detail (PW15)	17
How Partiwall® Works	5	Box Gutter Detail (PW16)	17
Fire	6	Eave Closure Detail (PW03)	18
Acoustic	6	Partiwall® to OutRwall® - Transition Detail 1 (PW05)	18
Structural	7	Partiwall® to OutRwall® - Transition Detail 2 (PW06)	19
Isolated Support for Stairs	7	Brick Veneer Wall - Junction Detail 1 (PW07)	19
Thermal	7	Brick Veneer Wall Junction - Detail 2 (PW08)	20
Wet Areas	7	Clad Wall - Junction Detail (PW09)	20
Materials	8	4-Way Intersecting Wall - Plan Detail (PW11)	21
Linings for Occupancy Areas	8	Typical Corner - Plan Detail (PW10)	21
Partiwall® Systems	9	Internal Wall/Partiwall® Junction (PW22)	22
FRL 60/60/60 (System Type 25TP)	9	Wall Penetrations - Plan Details (PW12)	22
FRL 90/90/90 (System Type 41TP)	10	uPVC Pipe Penetration at Roof Space (PW19)	23
FRL 90/90/90 (System Type 50TP)	11	Power Cables Penetrations at Roof Space (PW20)	23
Details	12	Copper Pipe Penetration at Roof Space (PW21)	24
Perspective - Section at Roof	12	Installation of Shaftliner™ Fire Barrier	25
Typical Floor/Wall Junction	12	Protection From Weather	25
Typical Arrangement of Services	12	Do's and Don'ts	25
Concrete Base Details (PW02a)	13	Step 1-7	26
Concrete Base Details (PW02b)	13	Step 8-11	27
Step in Slab Details (PW04a)	13	Contacts and Further Information	28
Step in Slab Details (PW04b)	13	Sustainability	28
Typical Floor/Wall Junction (PW01)	14	Warranty	28
Typical Floor/Wall Junction (PW17)	14	Health and Safety	28
Staggered Floor Detail (PW18)	15	Technical Enquires	28
		Sales Enquires	28

Introduction

The pioneering Boral Partiwall® system is one of the most widely used separating wall systems in the Australian market.

Excellent acoustic performance, ease of construction and design flexibility has made Boral Partiwall® the system of choice on many multi-residential townhouse projects.

Continuous innovation of the Partiwall® system has kept it in step with the changing regulatory and market requirements over the years. Some of the Partiwall® innovations that can be found in this brochure and at www.boral.com.au/partiwall are as follows:

- Compliance with Building Code of Australia (BCA) requirements for 'discontinuous construction' supported in BCA Illustrated.
- Independent assessment shows that Partiwall® acoustically outperforms a double-leaf brick wall¹.
- New cost effective configuration to achieve FRL 90/90/90.
- Staggered aluminium clips on opposite sides of Partiwall® stud for offset floors.
- Services penetrations through Shaftliner™ barrier allowed in the roof space.

Boral Partiwall® is an innovative solution for separating walls between attached dwellings (Class 1a buildings). For construction of timber framed apartment buildings (Class 2) up to 3 storeys contact Boral TecASSIST® at www.boral.com.au/tecassist

The Boral Partiwall® system utilises certain components and accessories as specified in this brochure. Material substitution in the Partiwall® system and non-compliance with the instructions in this brochure may lead to a reduction in performance and void reports in support of BCA compliance.

¹ Renzo Tonin & Associates Doc Ref: TE405-01F02 (rev 3) Comparisons of Acoustic Performance (dated 3 Feb 2010)

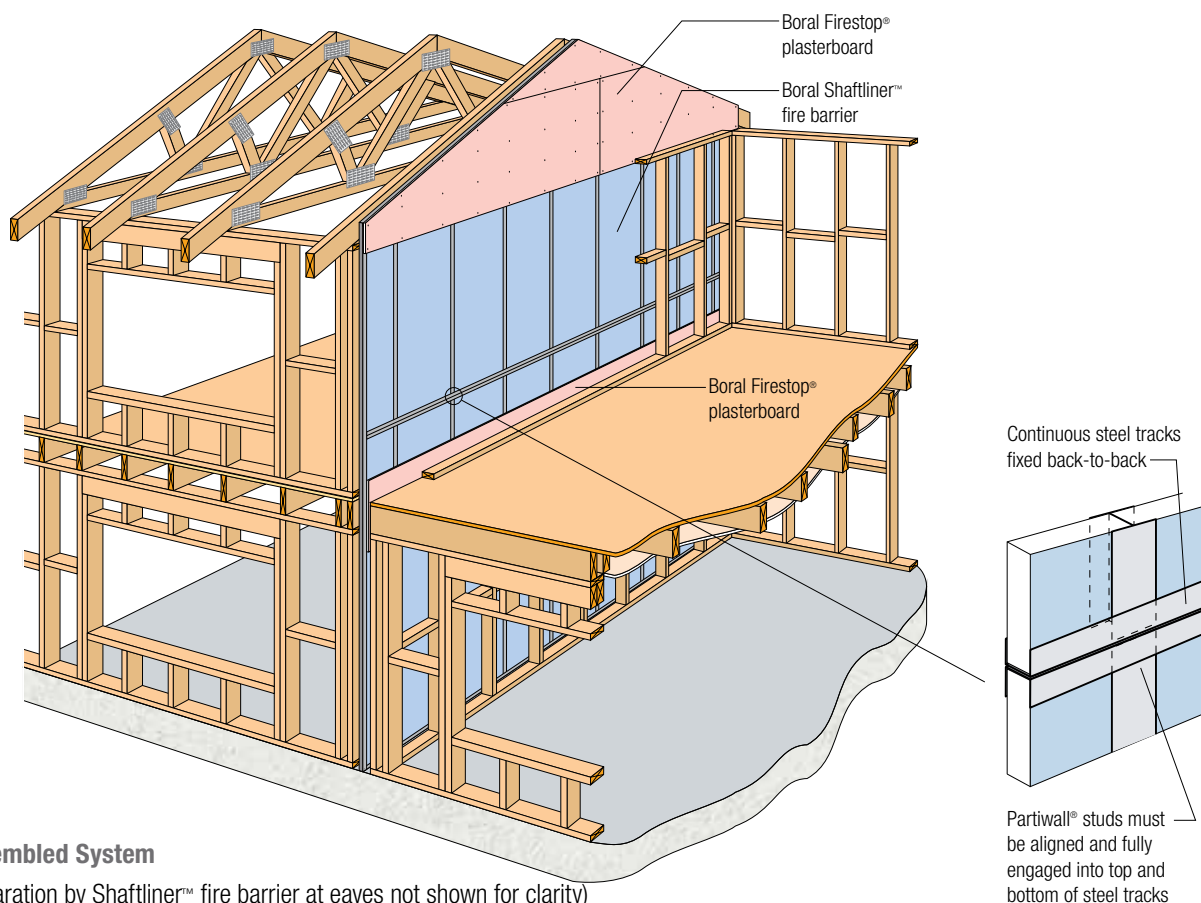

Assembled System

(Separation by Shaftliner™ fire barrier at eaves not shown for clarity)

» Introduction

What is Partiwall® ?

The Partiwall® system is essentially a twin wall system, which incorporates 25mm fire-resistant Shaftliner™ plasterboard panels within the wall cavity.

Partiwall® was developed to suit the normal pattern of construction and follow-up trades. The fire-resistant Shaftliner™ panels are held in position by lightweight steel H or I section studs. No plasterboard fixing, jointing or finishing is required at this stage. This installation procedure is easily carried out during the framing stage. The internal wall linings are installed at the plastering stage using conventional installation methods.

Boral Partiwall® has been tested and certified to meet Fire Resistance Levels (FRL's) of 60/60/60 and 90/90/90 and acoustic performance up to and exceeding $R_w + C_{tr} = 50\text{dB}$.

The inclusion of Boral's 10mm Soundstop® and 13mm ENVIRO Soundstop® plasterboard provides additional options where the BCA requires $R_w + C_{tr} = 50\text{dB}$ acoustic rating.

This brochure covers timber framed Partiwall® systems. Boral Plasterboard can also advise on using the Partiwall® system in steel framed buildings.

Features and Benefits

- Cost effective and fast to construct.
- No wet trades are required.
- Modular construction of Shaftliner™ fire barrier permits easy installation at framing stage - no additional trades are required.
- Permits easy inclusion of service penetrations, such as switches, power points, light fittings and pipes within the partition.
- Internal wall linings are installed at the plastering stage as per normal construction sequence.

How Partiwall® Works

While in a conventional fire rated wall system fire resistant outer linings provide protection to the wall substrate, in the Partiwall® system the main fire barrier is located within the wall cavity and is designed to protect the structure on the side opposite to the fire. At the same time, the Shaftliner™ fire barrier relies on this structure for the support as the structure on the fire side loses stability or collapses.

In order to ensure that the Shaftliner™ fire barrier is not damaged by the collapse of the structure on the fire side, Partiwall® aluminium clips are utilised to attach the fire barrier to the timber frames on both sides. As the clips on the fire side melt, the Shaftliner™ fire barrier is disconnected from the collapsing structure and is supported by the clips and the structure on the protected side for the specified fire rating period.

Steel clips must not be used in the Partiwall® system as their use compromises the integrity of the Shaftliner™ fire barrier during the fire.

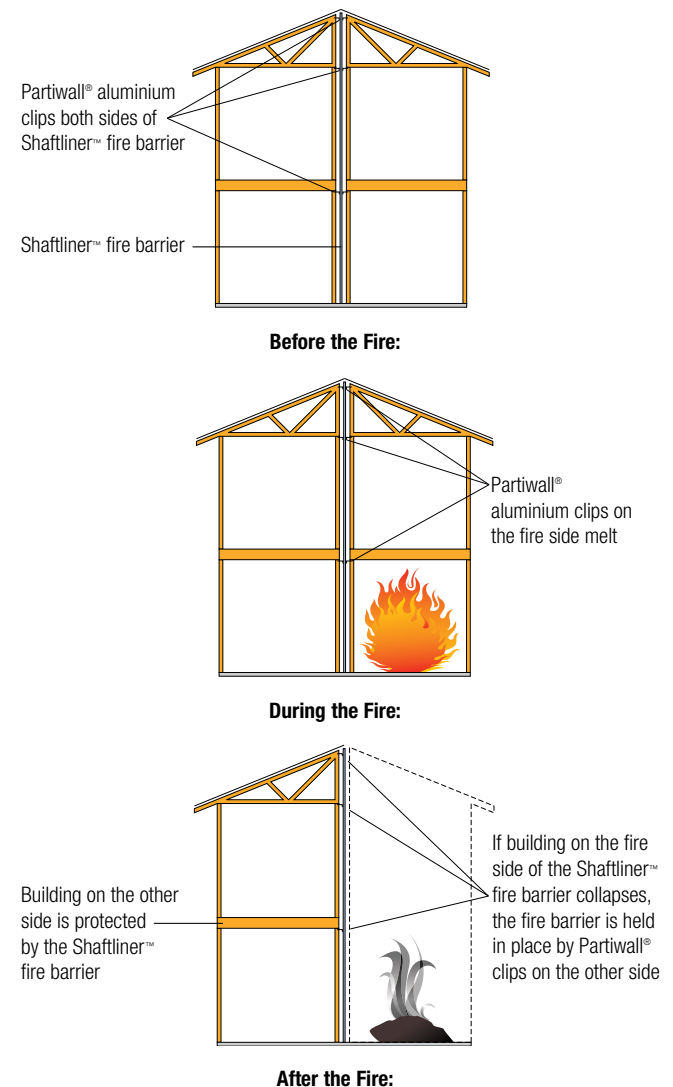

Design Considerations

Fire

The Partiwall® system has been fire tested at CSIRO's laboratory at North Ryde in Sydney. The performance of the various systems has been assessed in CSIRO's assessment number FSV 0381, FCO-2256, FCO-2713, FCO-1446 and FCO-2016.

Partiwall® system provides Fire Resistance Levels (FRL) of 60/60/60 and 90/90/90. In the case of a fire, the structural adequacy and load bearing capacity is provided by the wall frame on the other side of Shaftliner™ fire barrier.

As the primary fire barrier (the Shaftliner™ panels) is located in the cavity between the frames, the system permits easy inclusion of services such as water and waste pipes, electrical and communications cables, as long as the primary barrier is not penetrated. Service penetrations are allowed through Shaftliner™ fire barrier in the roof space.

The following penetrations, individually or in combinations, or back-to-back, are allowed in the outer linings and are not required to be fire rated:

- normal residential electrical switches and power points
- data, communications or electrical cables passing through the linings into the cavity
- copper, galvanized steel, or plastic water or wastewater pipes of up to 50mm nominal diameter passing through the linings into the cavity
- cabinets, baths, shower bases or vanities.

For other penetrations contact Boral TecASSIST® 1800 811 222.

The following requirements are essential to maintain the fire-rating integrity and acoustic performance of the Partiwall® Shaftliner™ fire barrier:

- Use only the specified Partiwall® clips to attach the Partiwall® studs to framing members. In the event of a fire, this aluminium clip is designed to melt to allow the framing members on the fireside to fall away leaving the Shaftliner™ fire barrier intact.
- Other than the clips, there should be no attachments to the Shaftliner™ fire barrier.
- There should be no penetrations through the Shaftliner™ fire barrier apart from approved penetrations in the roof space. Refer to Building Surveyor for advice.

For design and installation requirements of internal plasterboard wall linings, refer to Boral Plasterboard Installation Manual.

Acoustic

The Partiwall® system has been the subject of a series of acoustic tests at the CSIRO Acoustic Laboratory at Highett, Victoria.

Acoustical estimates have been determined by Renzo Tonin and Associates Pty Ltd.

Partiwall® satisfies BCA acoustic provisions for Class 1 buildings of $R_w = 50\text{dB}$ and $R_w + C_{tr} = 50\text{dB}$ for separating walls and $R_w + C_{tr} = 25\text{dB}$ and $R_w + C_{tr} = 40\text{dB}$ acoustic separation of adjoining soil and waste pipes within the cavity.

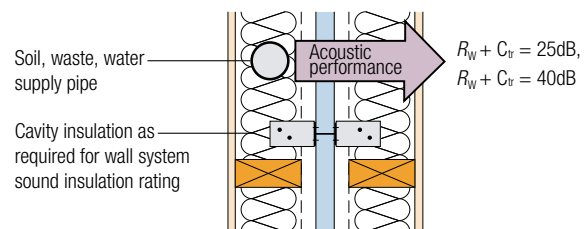

Note: To achieve $R_w 45$ or $R_w + C_{tr} 40$ separation, insulation is required in the wall cavity on the opposite side of the pipe.

Plan - Partiwall Basic Configuration

Small penetrations of linings in occupancy areas ie switches, power points, light fittings and pipes do not need to be acoustically sealed.

Shaftliner™ fire barrier base and internal lining junctions with floors must be sealed with an approved fire acoustic sealant.

To maintain acoustic performance, service pipes must not be in contact with the Shaftliner™ fire barrier.

All services should be run through the framing. Insulation thicker than the stud framing is allowed.

The clear distance between the Shaftliner™ fire barrier and wall framing on both sides should not be less than 20mm nor more than 40mm.

The 16mm Firestop® plasterboard laminated to the Shaftliner™ fire barrier should not come into contact with the stud or floor framing. It is recommended the gap between Shaftliner™ fire barrier and timber framing be increased to a minimum 25mm on the Firestop® side to ensure adequate clearance.

Partiwall® complies with BCA requirements for 'discontinuous construction' (supported in BCA Illustrated).

» Design Considerations

Isolated Support for Stairs

'BCA COMPLIANT, SOUND AND FIRE RATED TIMBER FRAMED CONSTRUCTION – Design and Construction Guide for Class 1a Attached Buildings – Townhouses', states that impact sound from stair usage typically vibrates its way into separating walls, thus creating a greater likelihood of sound passing across the wall into attached dwellings. The recommended way to prevent this is by isolating the stair structure. Options include:

- Using the stringers to support the stairs, at each floor level, without intermediate support from the separating wall in between, ie free standing, or alternatively
- Using newel posts rather than the separating wall to support the stair structure
- Keeping the treads clear off the separating wall.

Structural

Maximum Permissible Height

Height of the Shaftliner™ fire barrier should not exceed 12 metres.

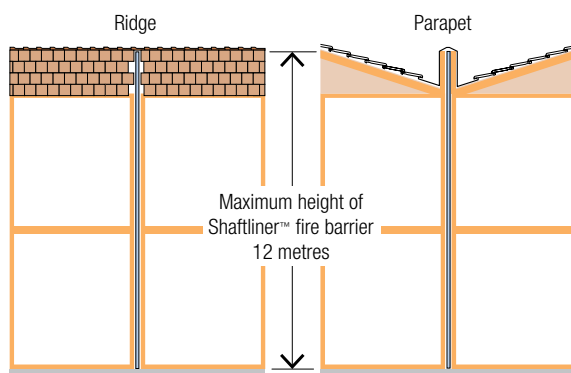

Support Clip Separation

Clips each side of the Shaftliner™ fire barrier must be spaced at no more than 3000mm vertically and 600mm horizontally UNO.

Control Joints

Where control joints are necessary in the Shaftliner™ fire barrier, contact Boral TecASSIST® 1800 811 222 for construction details.

Wind Speed

Partiwall® is suitable for wind classification N1 and N2 as determined by AS 4055, Wind loads for housing. For higher wind

classifications Boral Plasterboard recommends temporary propping of Shaftliner™ fire barrier during construction until the building is enclosed. Propping details are to be designed by a suitably qualified Structural Engineer. Where Partiwall® is proposed in cyclonic areas contact Boral Plasterboard for advice.

Framing

Timber framing to be designed by a suitably qualified Structural Engineer to meet BCA requirements and relevant Australian Standards.

Note: Stud spacing not to exceed 600mm centres.

Thermal

Total R values of Partiwall® systems provided in this brochure have been assessed by James M. Fricker in Melbourne based on AS/NZS 4859.1:2002/Amdt 1 2006, Materials for the thermal Insulation of Buildings (James M. Fricker Report i274b).

Independent assessment shows that Partiwall® achieves thermal resistance ratings from R2.89 to R5.76.

Wet Areas

In areas classified as Wet Areas in accordance with the BCA, the following linings should be used in lieu of the specified internal linings in order to achieve required fire and acoustic ratings:





Wet Area Linings	
Specified Internal Lining	Wet Area Lining
10mm Regular plasterboard	10mm Wet Area Board™
2 x 10mm Regular plasterboard	2 x 10mm Wet Area Board™ Or 1 x 6mm Villaboard® + 1 x 10mm Wet Area Board™
10mm Soundstop® plasterboard	13mm Wet Area Board™
13mm ENVIRO Soundstop® plasterboard	13mm Wet Area Firestop® plasterboard Or 1 x 6mm Villaboard® + 1 x 10mm Wet Area Board™

For installation details of Boral Wet Area System refer Boral Plasterboard Installation Manual.

Materials

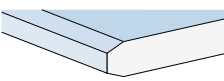
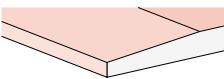

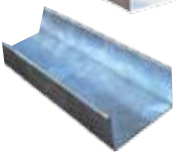





All materials are available from Boral Plasterboard and must be installed in accordance with current printed instructions. All materials should be stored clear of the ground and provided protection from damage and exposure to the elements.

The following materials are recommended for the installation of the Shaftliner™ fire barrier:

Boral Partiwall® Components		
Product Image	Item Description	Boral Item Codes
	25mm Shaftliner™ 600 x 3000mm	25SW0630
	25mm Shaftliner™ 600 x 3600mm	25SW0636
	16mm Firestop® 1200 x 2400mm	16FS1224
Partiwall® stud	25mm H-Stud x 3000mm	R25HS3055
	25mm H-Stud x 3600mm	R25HS3655
	50mm I-Stud x 3000mm	R051IS300055
	50mm I-Stud x 3600mm	R051IS360055
Partiwall® track	25mm Furring Channel Track x 3000mm	R014030
	51mm Wall Track x 3000mm	R040030
Partiwall® clip	Aluminium wall clip	RPWALLCLIP
		

Linings for Occupancy Areas

Linings in the occupancy areas (including Wet Area Firestop™ specified in some Partiwall® Wet Area Systems) do not need be fire rated and are constructed using the normal installation and finishing methods outlined in Boral Plasterboard Installation Manual. Base of linings must be acoustically sealed.

Boral Partiwall® Components		
Product Image	Item Description	Boral Item Codes
	Firesound® mastic, 450g tube	FBSOUND450
	Firesound® mastic, 600ml sausage	FBSOUND900
	6g x 25mm Type 'W' Timber Screws	S625WB
	10g x 40mm Type 'L' Laminating Screws Pkt 1000	S1040LB
	10g x 16mm Type 'D' Drill Point Wafer Head Screws	S1016DBB
	10g x 30mm Type 'D' Drill Point Wafer Head Screws	S1030DB
	30mm Galvanized Nails	NC3028PO
Boral Firepack™		
	Mineral wool packer 5m x 200 x 50mm, Pkt 3	IIPWBATT



Call your nearest Boral Plasterboard store for information on the range of insulation listed in the Partiwall® Systems Selector tables

Note:

Partiwall® performance values stated in this document are based on the use of materials and components listed above. Material substitution may effect the performance of Partiwall® systems. Please contact TecASSIST on 1800 811 822 for advice.

Partiwall® Systems



FRL 60/60/60 (System Type 25TP)

Assembly	System Reference	Nom Width (mm)	Stud Size (mm)	Pbd Weight (kg/m ²)	Fire FRL Basis	Acoustic Ratings			Total R Value (m ² K/W)
						R _w	R _w +C _{tr}	Insulation	
 <p>(Insulation not shown for clarity)</p>	25TP1010A								
	1x25mm Shaftliner™ panel 1x10mm Soundstop® plasterboard to each side of timber frame	225	70	36.9	60/60/60 FCO-2256	60	47	R2.0 glass wool or 100P14 both sides	-
		225	70			62	50	90G32 both sides	5.88
		265	70 or 90			59	48	110mm thick Boral Partiwall® Acoustic batt one side only	-
		265	70 or 90			63	53 CSIRO TL469a	110mm thick Boral Partiwall® Acoustic batt both sides	5.27
		285	90			62	50	R2.0 glass wool or 100P14 both sides	4.84 or 4.98
	295	90			65	55	110mm thick Boral Partiwall® Acoustic batt both sides	5.76	
 <p>(Insulation not shown for clarity)</p>	25TP1313A								
	1x25mm Shaftliner™ panel 1x13mm ENVIRO Soundstop® plasterboard to each side of timber frame	231	70	42.9	60/60/60 FCO-2256	61	49	R2.0 glass wool or 100P14 both sides	-
		231	70			62	50	90G16 both sides	5.29
		271	70 or 90			62	50 CSIRO TL429e	R2.0 glass wool both sides	4.84
		271	70 or 90			62	50 CSIRO TL444	100P14 both sides	4.92
		271	70 or 90			57	44 CSIRO TL429b	85P9 both sides	-
	281	90			65	55	110mm thick Boral Partiwall® Acoustic batt both sides	5.29	
 <p>(Insulation not shown for clarity)</p>	25TP2020								
	1x25mm Shaftliner™ panel 2x10mm Regular plasterboard to each side of timber frame	245	70	47.7	60/60/60 FCO-2256	64	50	R2.0 glass wool or 100P14 both sides	4.59 or 4.39
		285	70 or 90			65	51 CSIRO TL429r	R1.5 glass wool both sides	3.69
		285	70 or 90			65	51	70P14 both sides	3.86
	295	90			67	56	110mm thick Boral Partiwall® Acoustic batt both sides	5.59	

- For explanation of System Reference notation refer Section B1 of Boral Selector+ Plasterboard Systems.
- Insulation abbreviation: XXGYY = Glasswool insulation in format of thickness (mm), G (Glasswool), Density (kg/m³). XXPYY = Polyester insulation in format of thickness (mm), P (Polyester), Density (kg/m³).
- Where two stud sizes are nominated for a particular wall width, the gap from the stud to the Shaftliner fire barrier:
 - provides a maximum allowable gap of 40mm for the 70mm stud or
 - meets the BCA requirement of a 20mm gap for the 90mm stud.

» Partiwall® Systems



FRL 90/90/90 (System Type 41TP)

Assembly	System Reference	Nom Width (mm)	Stud Size (mm)	Pbd Weight (kg/m ²)	Fire FRL Basis	Acoustic Ratings			Total R Value (m ² K/W)
						R _w	R _w +C _{tr}	Insulation	
 <p>(Insulation not shown for clarity)</p>	41TP1010								
	1x16mm Firestop® plasterboard laminated on one side to 1x25mm Shaftliner™ panel	281	70 or 90	47.1	90/90/90 FCO-2713	63	50	R2.0 glass wool or 100P14 both sides	4.90 or 4.98
	1x10mm Regular plasterboard to each side of timber frame	281	70 or 90			64	52 CSIRO TL482a	110mm thick Boral Partiwall® Acoustic batt both sides	-
		301	90			67	55	110mm thick Boral Partiwall® Acoustic batt both sides	5.35
 <p>(Insulation not shown for clarity)</p>	41TP1010A								
	1x16mm Firestop® plasterboard laminated on one side to 1x25mm Shaftliner™ panel	241	70	49.9	90/90/90 FCO-2713	60	49	R2.0 glass wool or 100P14 one side only	-
	1x10mm Soundstop® plasterboard to each side of timber frame	241	70			63	51	R2.0 glass wool or 100P14 both sides	4.55 or 4.70
		281	70 or 90			61	50	R2.0 glass wool or 100P14 one side only	2.89 or 2.93
		281	70 or 90			66	54	R2.0 glass wool or 100P14 both sides	-
		281	70 or 90			67	55	110mm thick Boral Partiwall® Acoustic batt both sides	5.35
 <p>(Insulation not shown for clarity)</p>	41TP1313A								
	1x16mm Firestop® plasterboard laminated on one side to 1x25mm Shaftliner™ panel	247	70	55.9	90/90/90 FCO-2713	62	50	R2.0 glass wool or 100P14 one side only	-
	1x13mm ENVIRO Soundstop® plasterboard to each side of timber frame	247	70			64	52	R2.0 glass wool or 100P14 both sides	4.56 or 4.71
		287	70 or 90			62	51	R2.0 glass wool or 100P14 one side only	2.90 or 2.94
		287	70 or 90			67	55	R2.0 glass wool or 100P14 both sides	4.91 or 4.99

- For explanation of System Reference notation refer Section B1 of Boral Selector+ Plasterboard Systems.
- Insulation abbreviation: XXGY = Glasswool insulation in format of thickness (mm), G (Glasswool), Density (kg/m³). XXPHY = Polyester insulation in format of thickness (mm), P (Polyester), Density (kg/m³).
- Where two stud sizes are nominated for a particular wall width, the gap from the stud to the Shaftliner fire barrier:
 - provides a maximum allowable gap of 40mm for the 70mm stud or
 - meets the BCA requirement of a 20mm gap for the 90mm stud.

» Partiwall® Systems

FRL 90/90/90 (System Type 50TP)

Assembly	System Reference	Nom Width (mm)	Stud Size (mm)	Pbd Weight (kg/m ²)	Fire FRL Basis	Acoustic Ratings			Total R Value (m ² K/W)
						R _w	R _w +C _{tr}	Insulation	
 <p>(Insulation not shown for clarity)</p>	50TP1010								
	2x25mm Shaftliner™ panel 1x10mm Regular plasterboard to each side of timber frame	250	70	54.6	90/90/90 FCO-1446 FCO-2016 FCO-2256	61	48	R2.0 glass wool or 100P14 both sides	-
		290	70 or 90			64	51	R2.0 glass wool or 100P14 both sides	4.94 or 5.02
		300	90			67	55	110mm thick Boral Partiwall® Acoustic batt both sides	5.59
 <p>(Insulation not shown for clarity)</p>	50TP1010A								
	2x25mm Shaftliner™ panel 1x10mm Soundstop® plasterboard to each side of timber frame	250	70	57.4	90/90/90 Cf NA FCO-1446 FCO-2016 FCO-2256	60	48	R2.0 glass wool or 100P14 one side only	-
		250	70			63	51	R2.0 glass wool or 100P14 both sides	4.58 or 4.23
		290	70 or 90			62	50	R2.0 glass wool or 100P14 one side only	-
		290	70 or 90			67	55	R2.0 glass wool or 100P14 both sides	4.94 or 5.02
 <p>(Insulation not shown for clarity)</p>	50TP1313A								
	2x25mm Shaftliner™ panel 1x13mm ENVIRO Soundstop® plasterboard to each side of timber frame	256	70	63.4	90/90/90 FCO-1446 FCO-2016 FCO-2256	62	50	R2.0 glass wool or 100P14 one side only	-
		256	70			65	53	R2.0 glass wool or 100P14 both sides	4.60 or 4.25
		296	70 or 90			63	52	R2.0 glass wool or 100P14 one side only	-
		296	70 or 90			68	56	R2.0 glass wool or 100P14 both sides	4.95 or 5.03

- For explanation of System Reference notation refer Section B1 of Boral Selector+ Plasterboard Systems.
- Insulation abbreviation: XXGYY = Glasswool insulation in format of thickness (mm), G (Glasswool), Density (kg/m³). XXPYY = Polyester insulation in format of thickness (mm), P (Polyester), Density (kg/m³).
- Where two stud sizes are nominated for a particular wall width, the gap from the stud to the Shaftliner fire barrier:
 - provides a maximum allowable gap of 40mm for the 70mm stud or
 - meets the BCA requirement of a 20mm gap for the 90mm stud.

Details

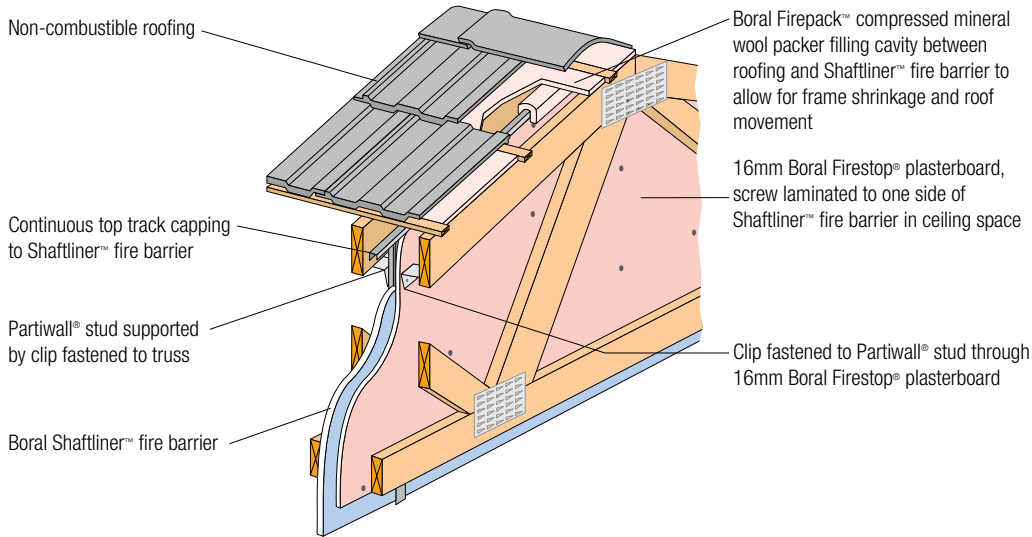

Perspective - Section at Roof

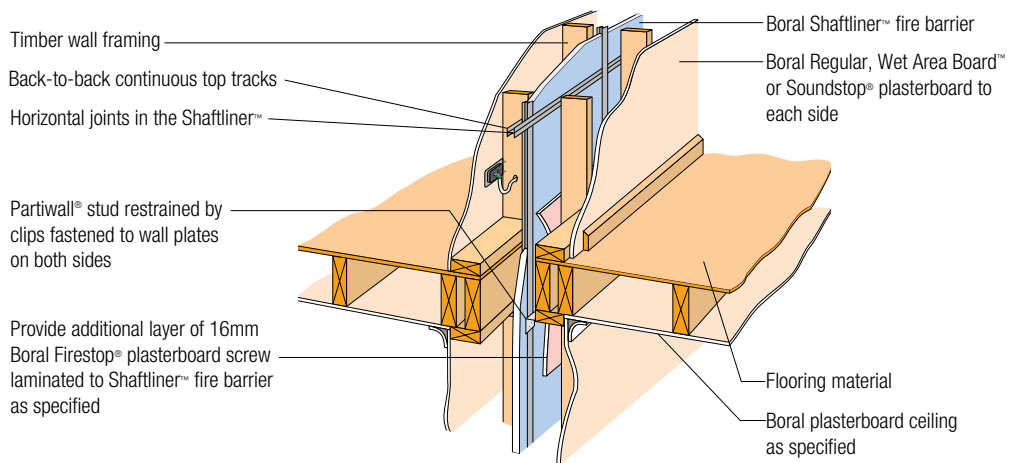

Typical Floor/Wall Junction

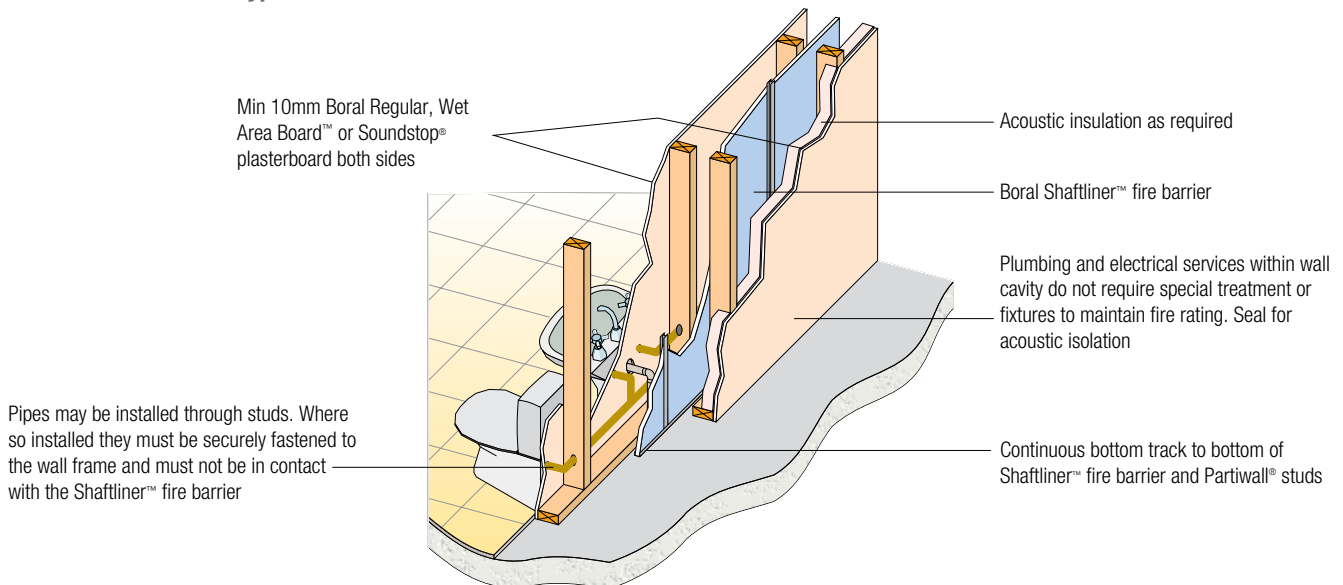

Typical Arrangement of Services

» Details

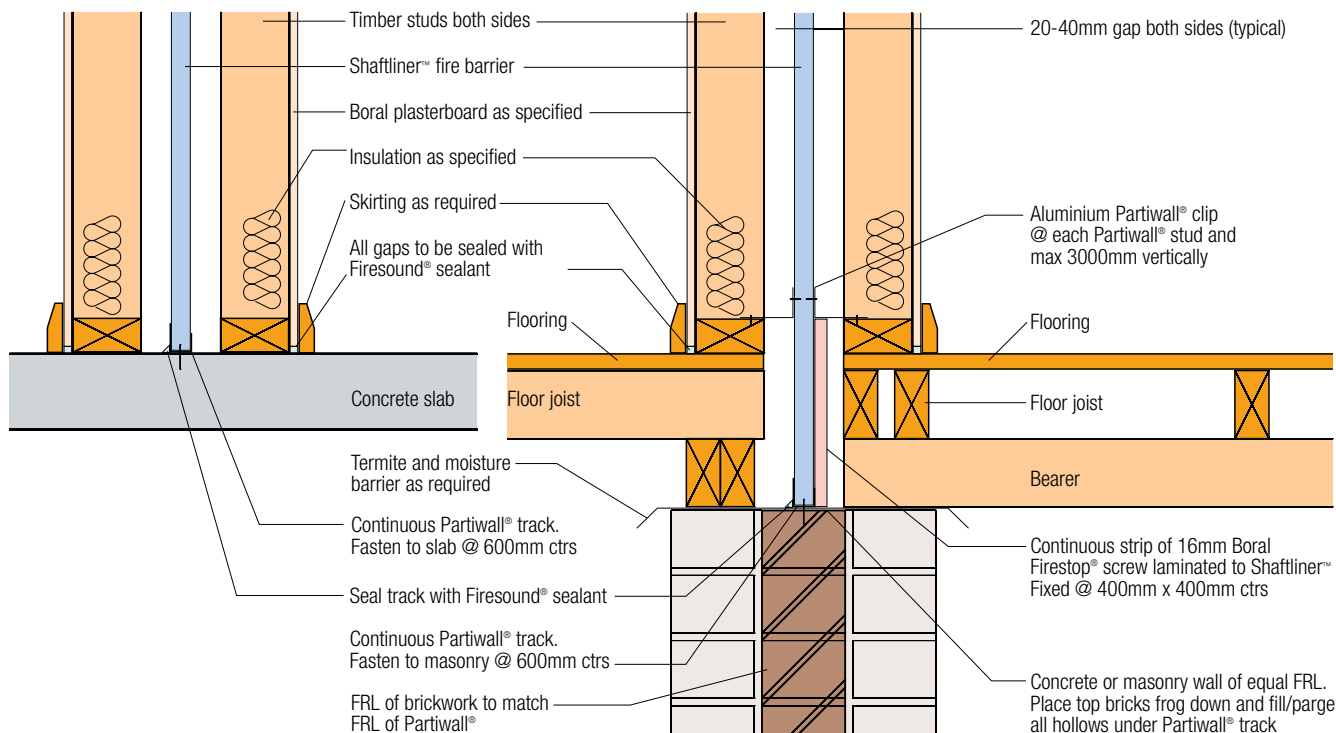

Concrete Base Detail - FRL 60/60/60 (PW02a)

Masonry Base Detail - FRL 60/60/60 (PW02b)

Notes:

- 1) Ensure all gaps are sealed with acoustic sealant.
- 2) Vertical support of Shaftliner™ fire barrier must not exceed 3000mm in any case.

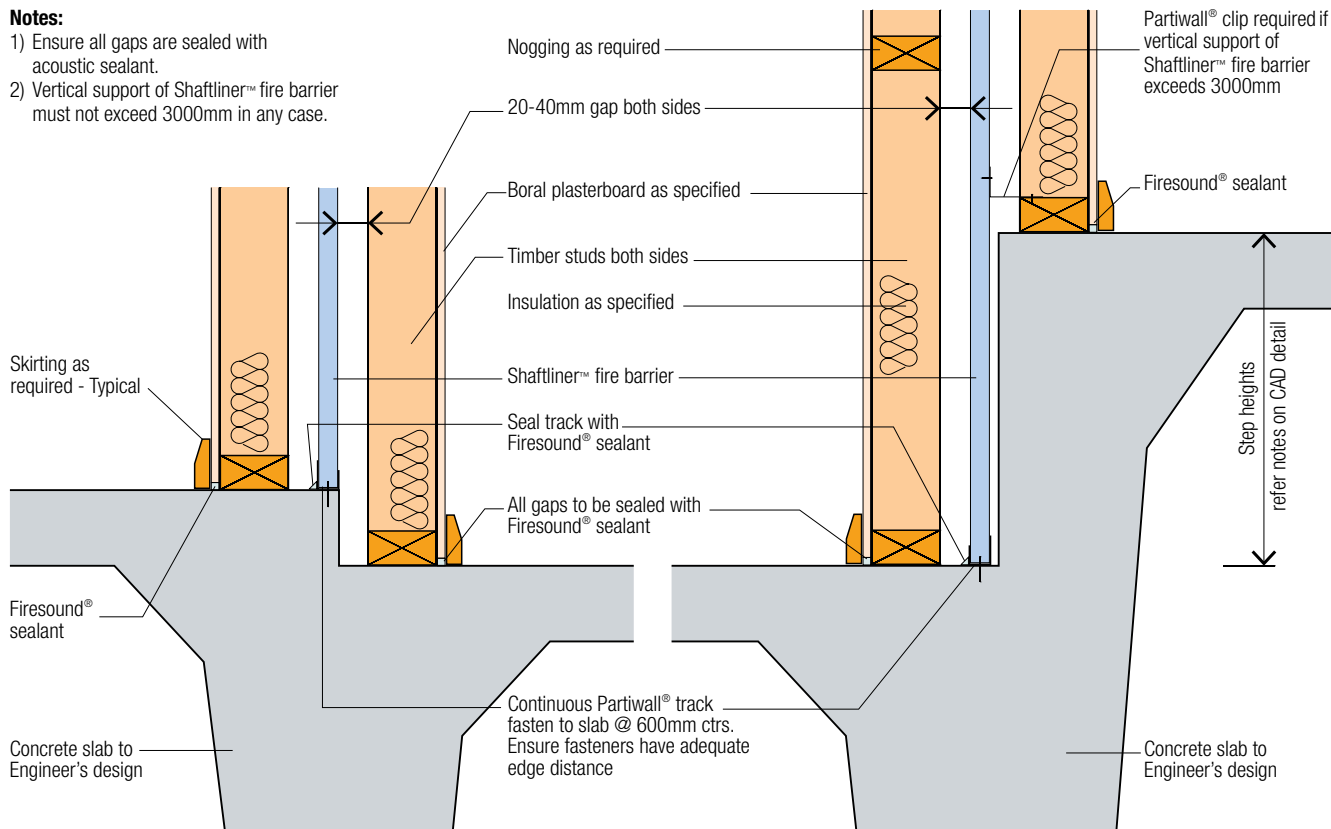

Step in Slab Detail - FRL 60/60/60 (PW04a)

Step in Slab Detail - FRL 60/60/60 (PW04b)

» Details

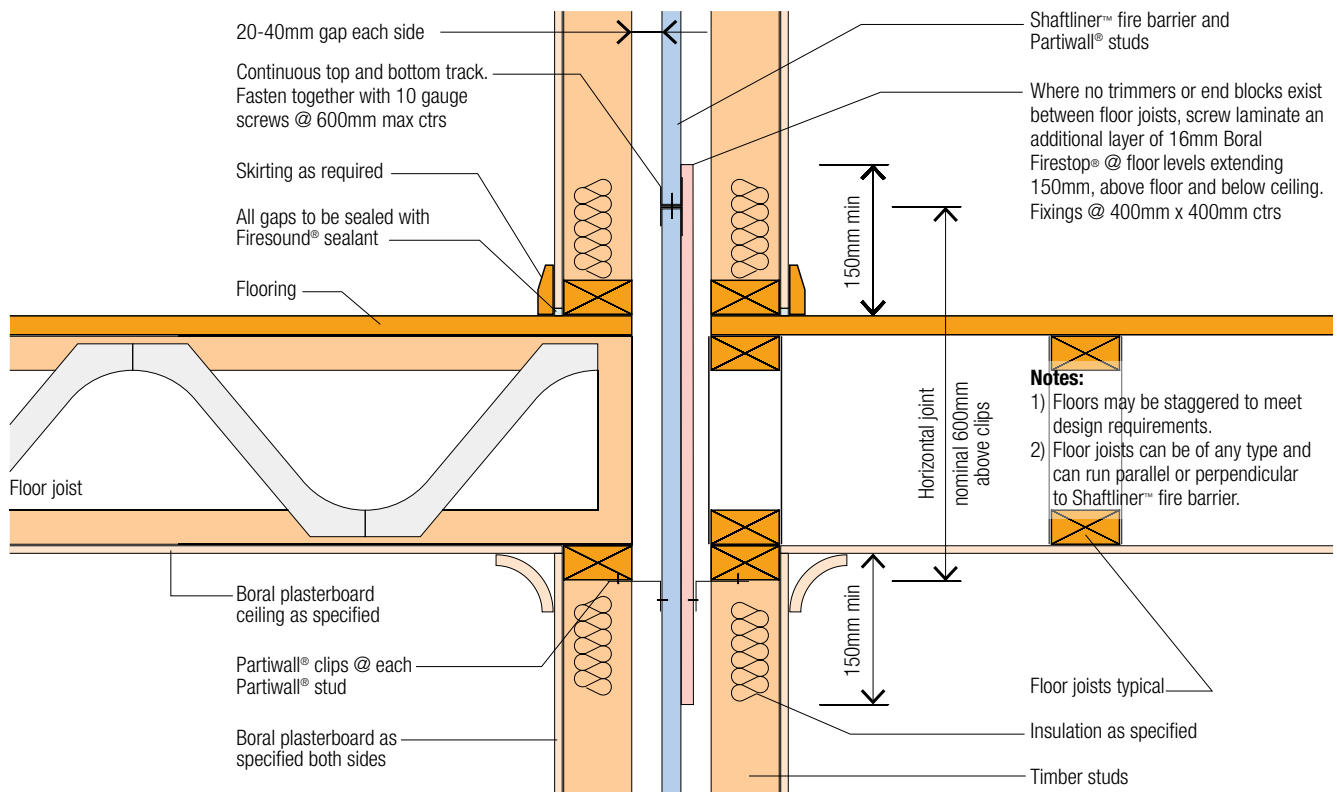

Typical Floor/Wall Junction - FRL 60/60/60 (PW01)

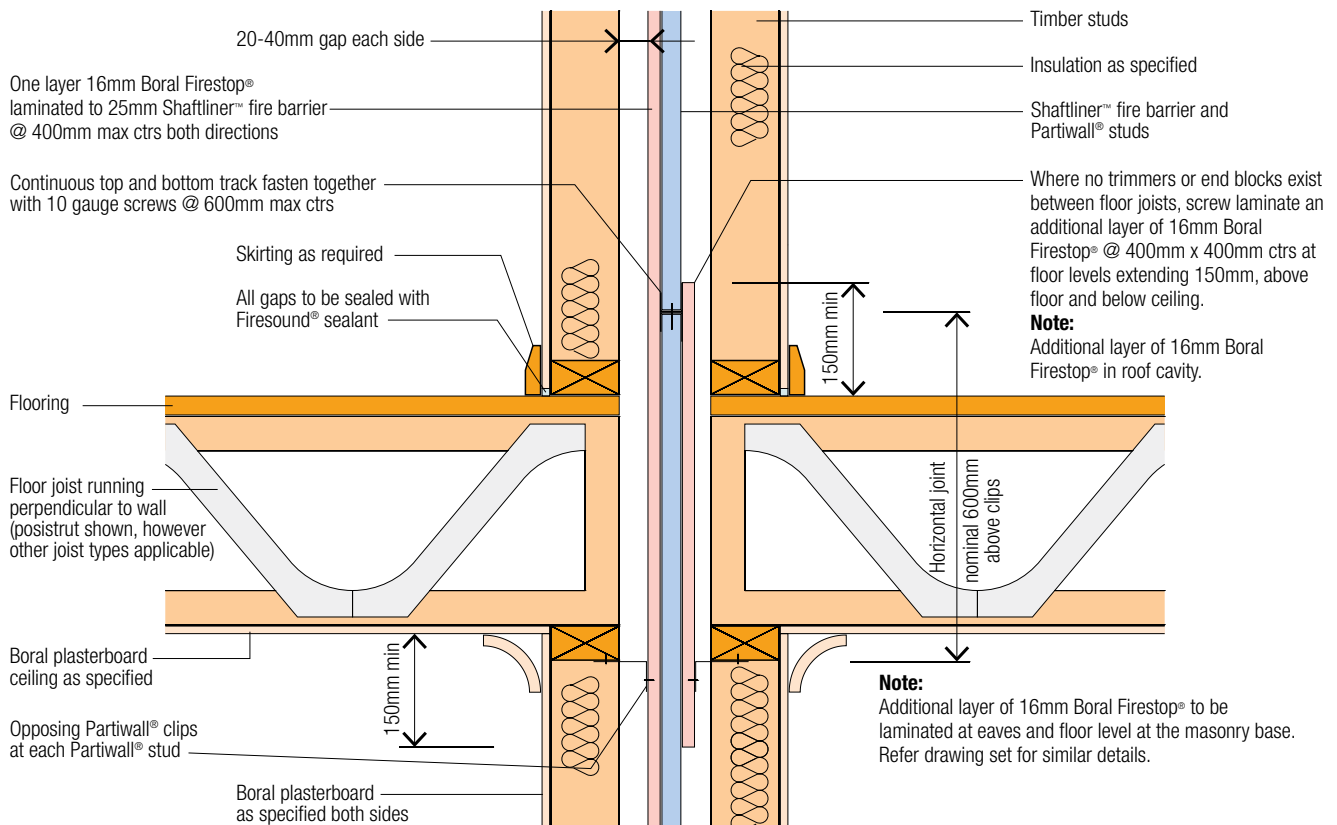

Typical Floor/Wall Junction - FRL 90/90/90 (PW17)

» Details

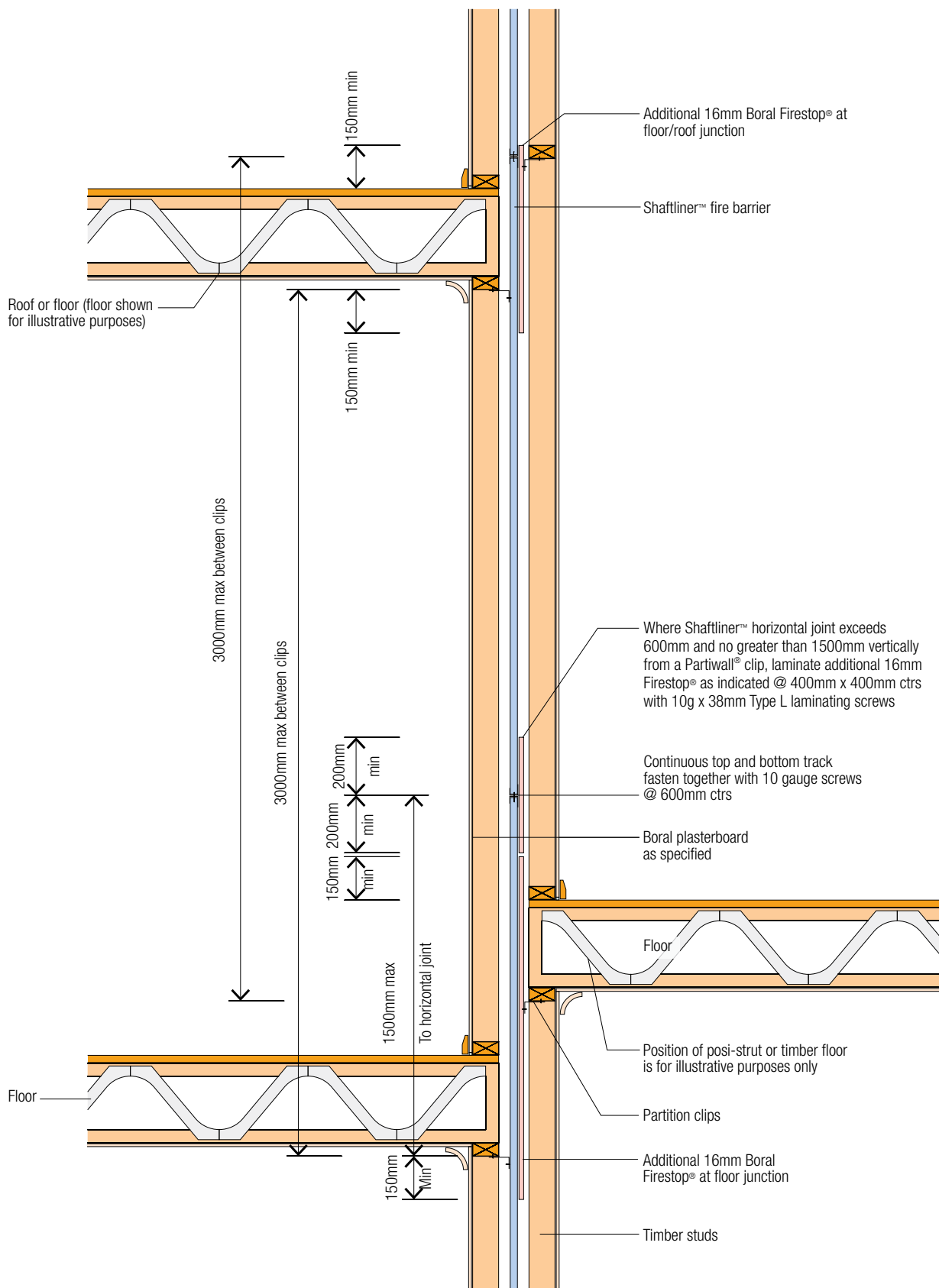

Staggered Floor Detail - FRL 60/60/60 (PW18)

» Details

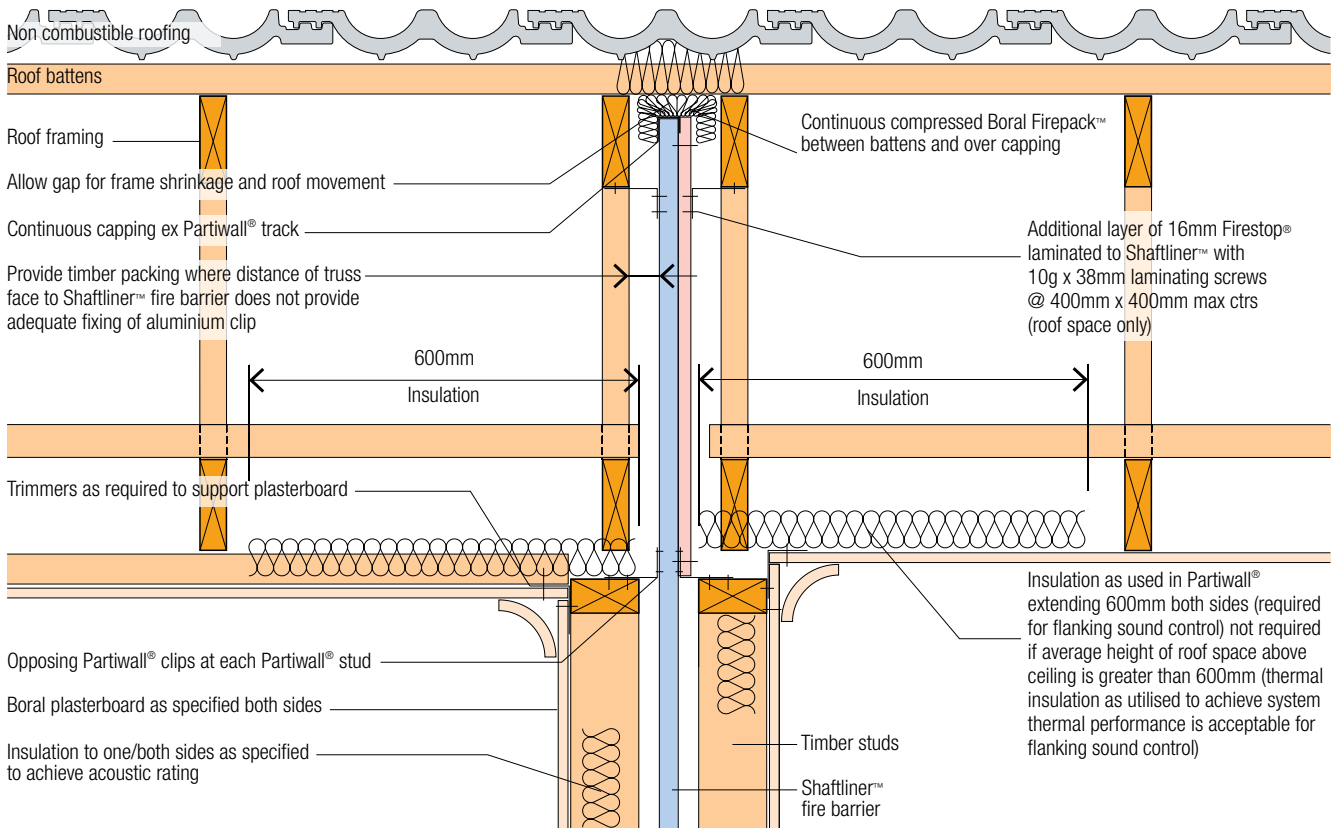

Pitched Roof - Wall/Roof Junction Detail - FRL 60/60/60 (PW13)

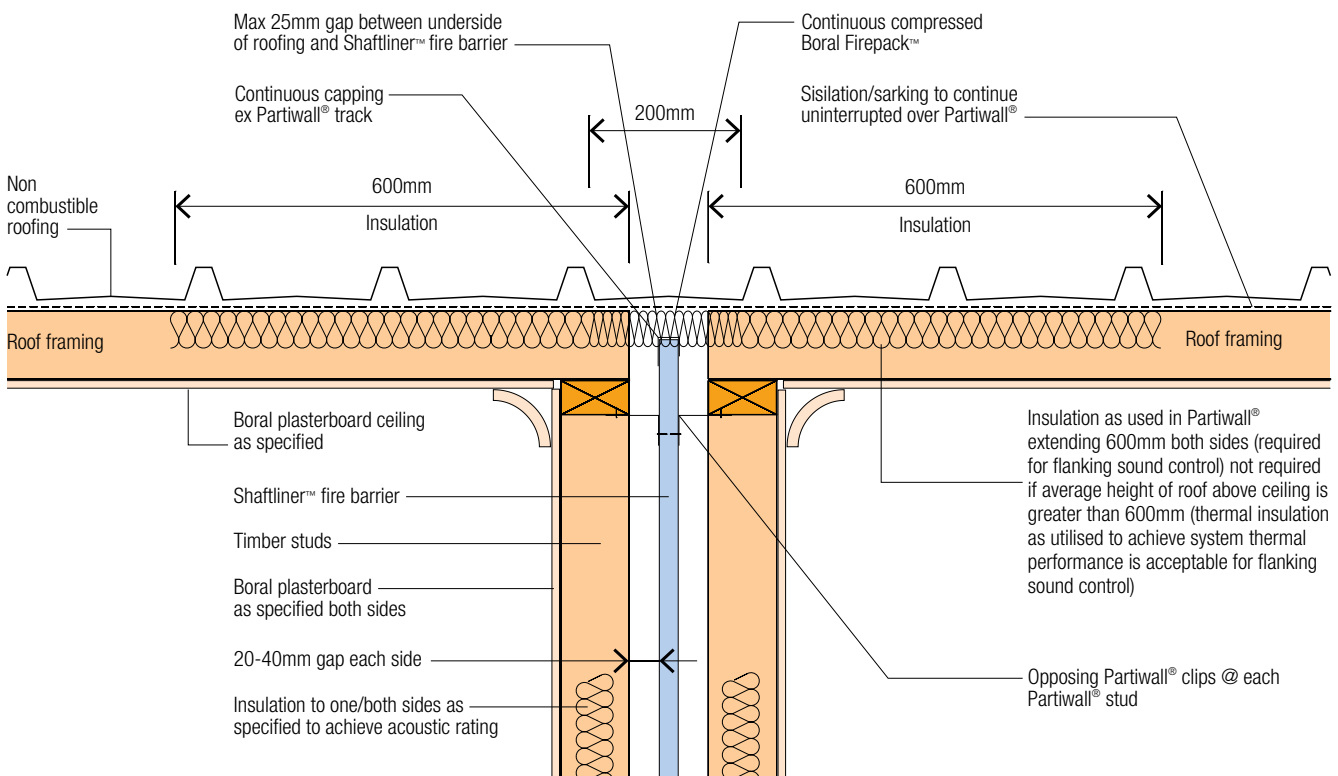

Flat Roof - Wall/Roof Junction Detail - FRL 60/60/60 (PW14)

» Details

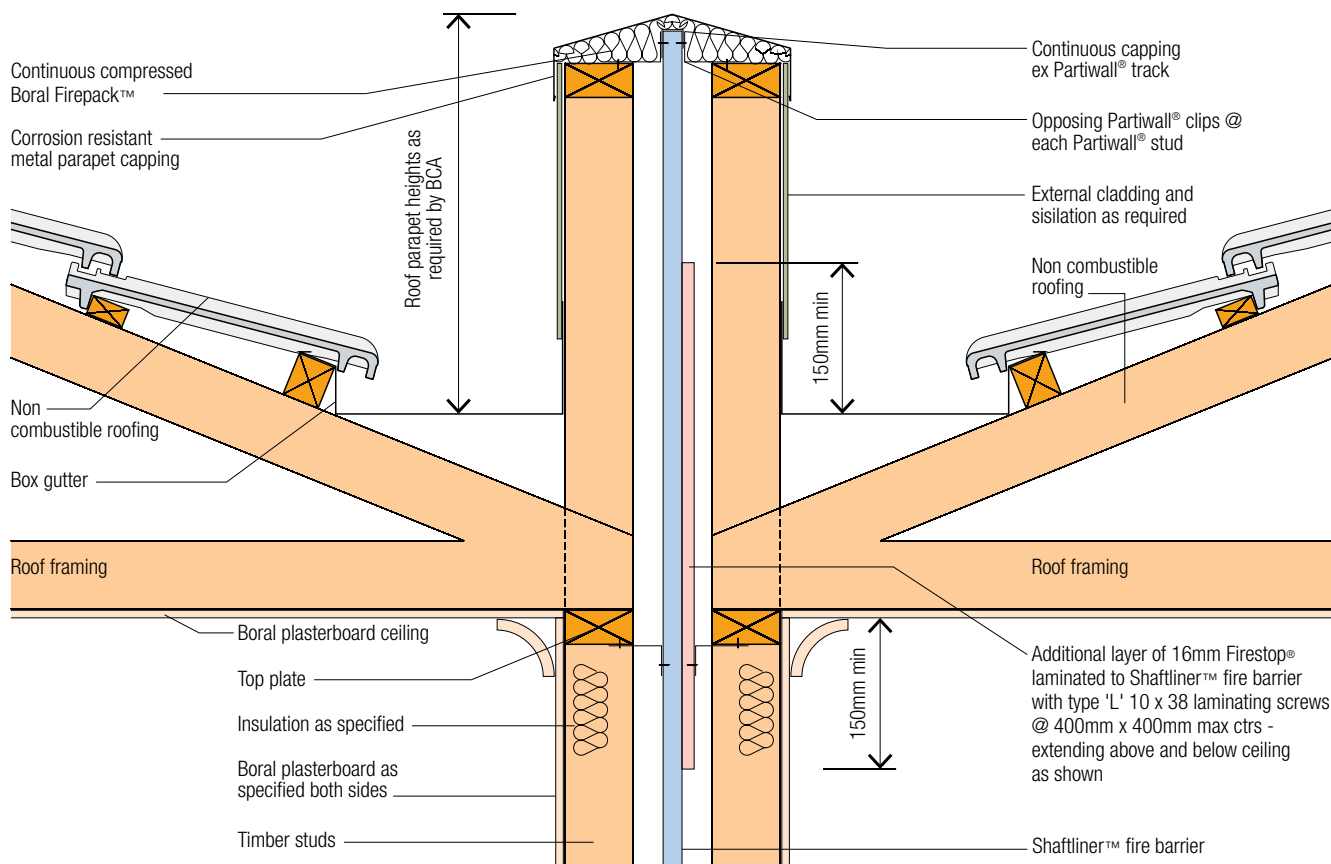

Roof Parapet - Junction Detail - FRL 60/60/60 (PW15)

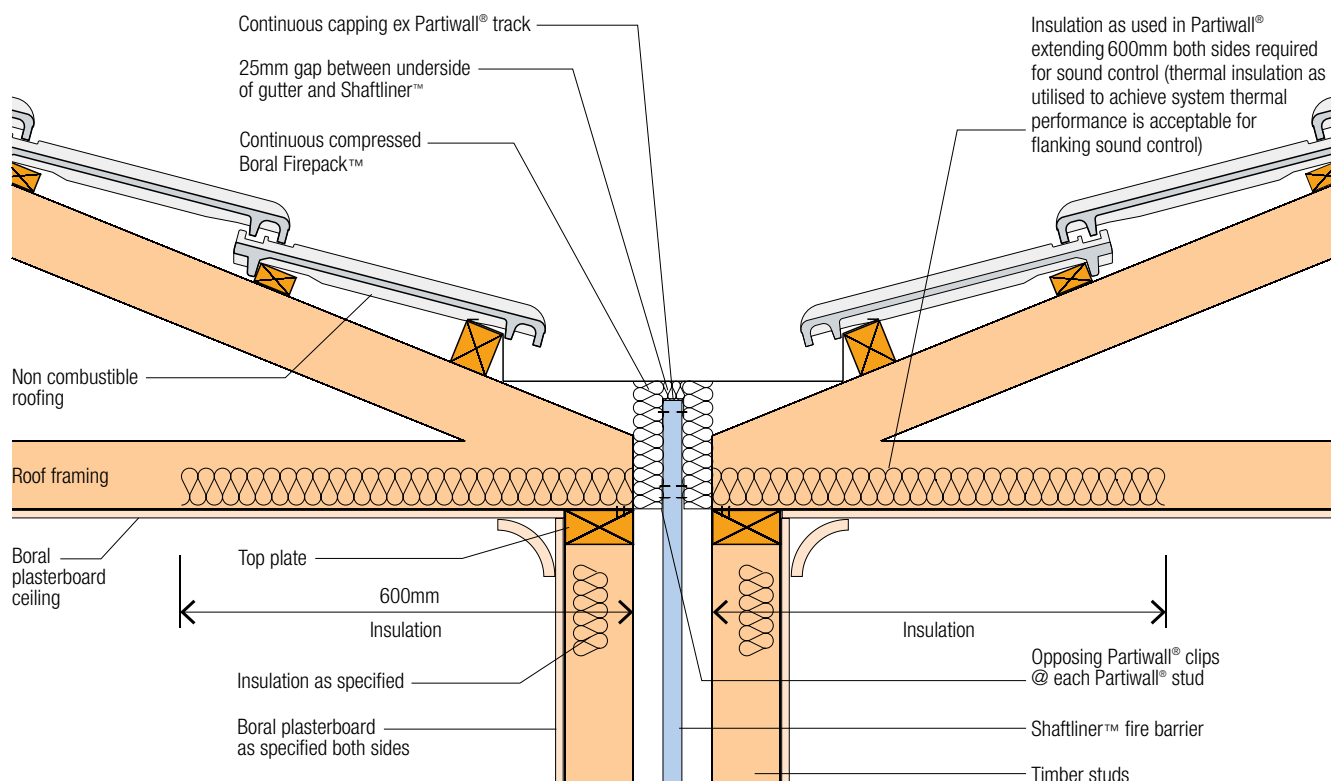

Box Gutter Detail - FRL 60/60/60 (PW16)

» Details

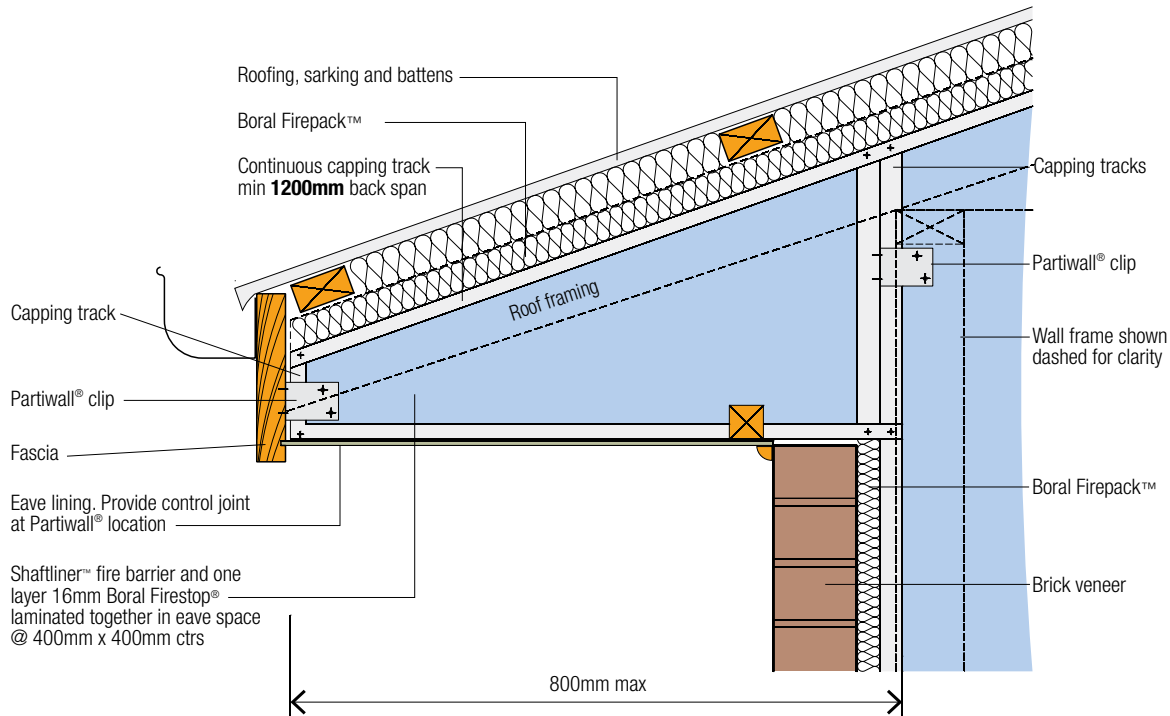

Eave Closure Detail - FRL 60/60/60 (PW03)

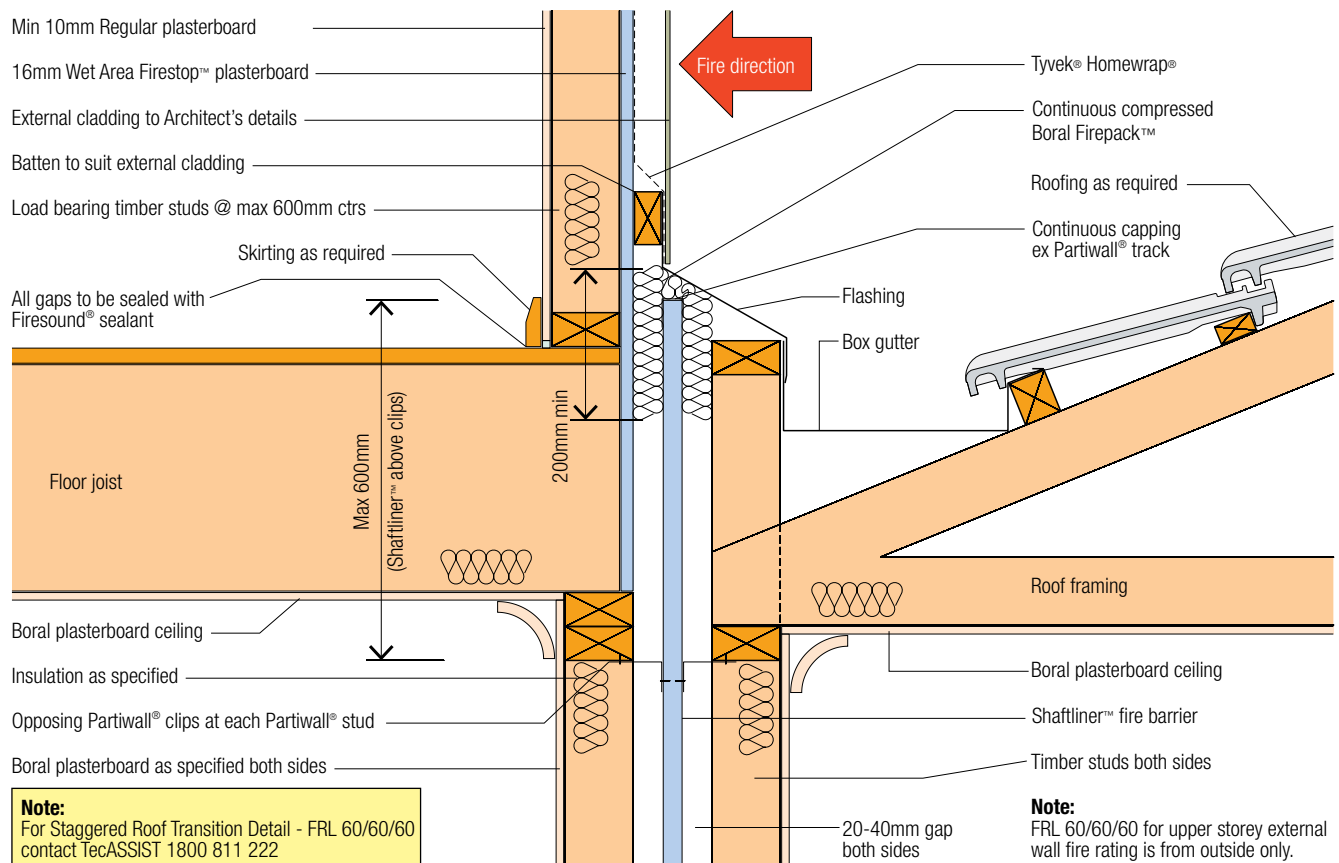

Partiwall® to OutRwall® - Transition Detail 1 - FRL 60/60/60 (PW05)

» Details

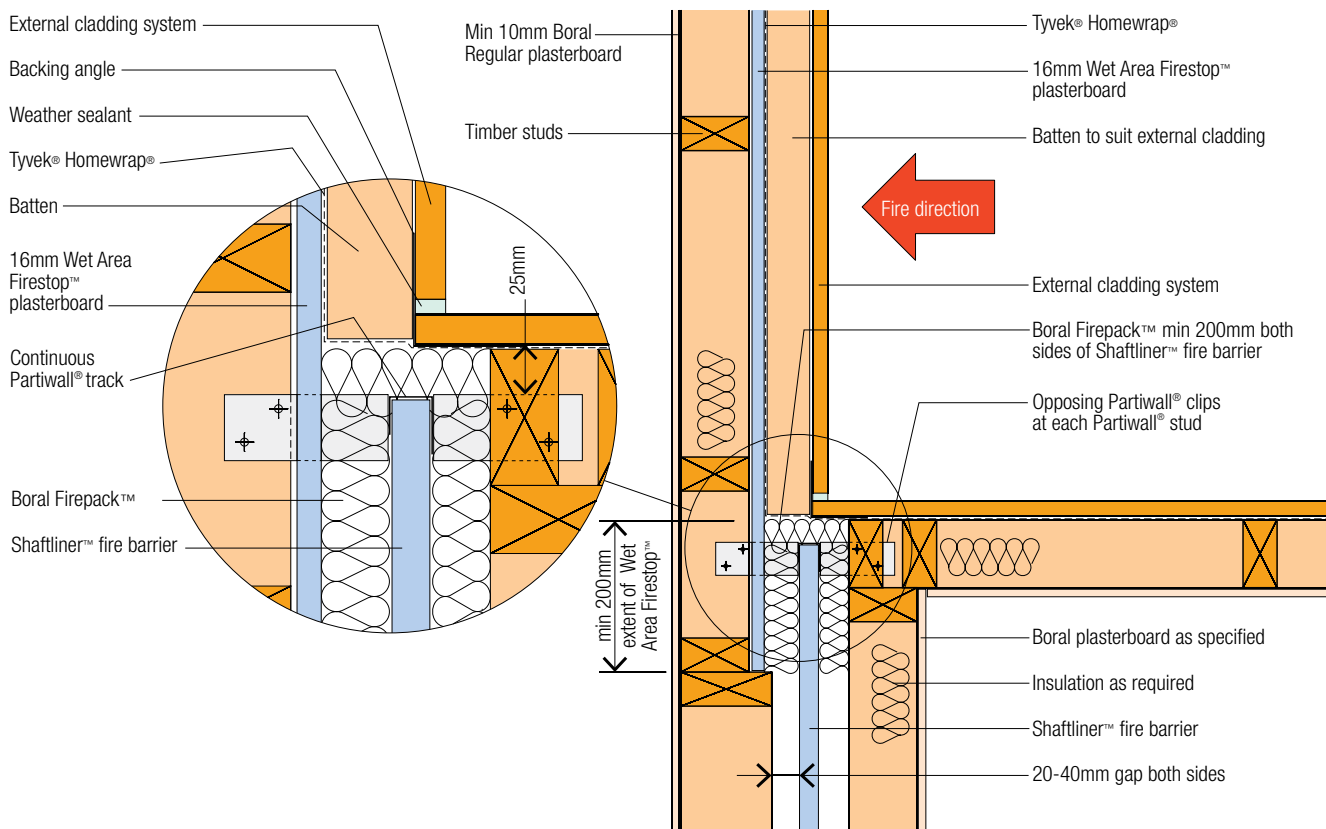

Partiwall® to OutRwall® - Transition Detail 2 - FRL 60/60/60 (PW06)

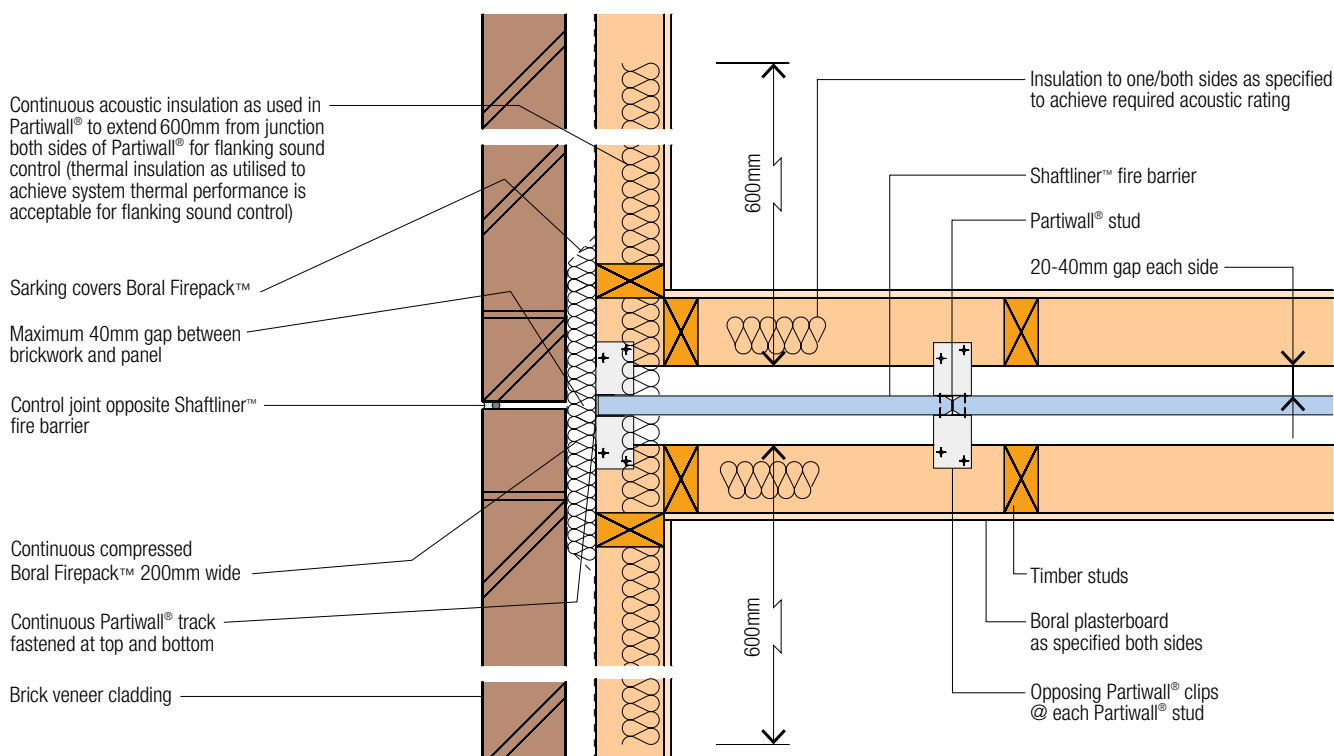

Brick Veneer Wall - Junction Detail 1 - FRL 60/60/60 (PW07)

» Details

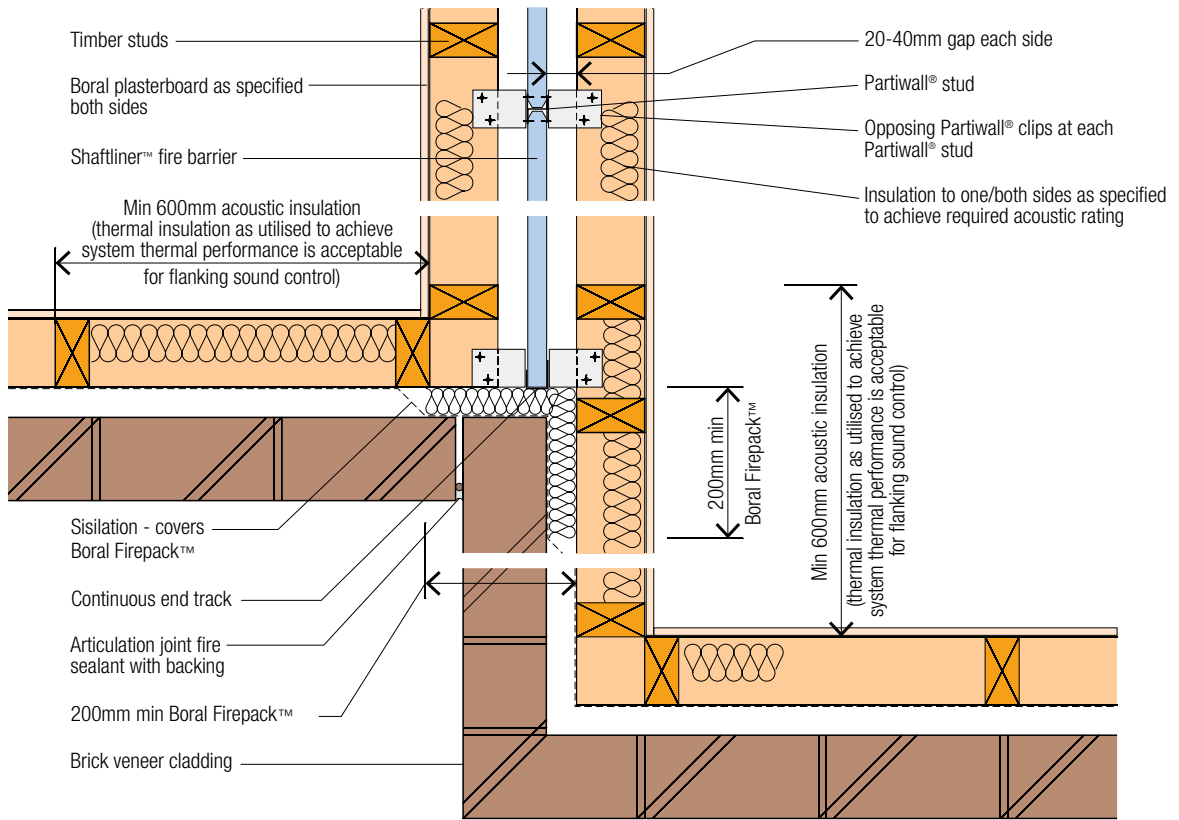

Brick Veneer Wall Junction - Detail 2 - FRL 60/60/60 (PW08)

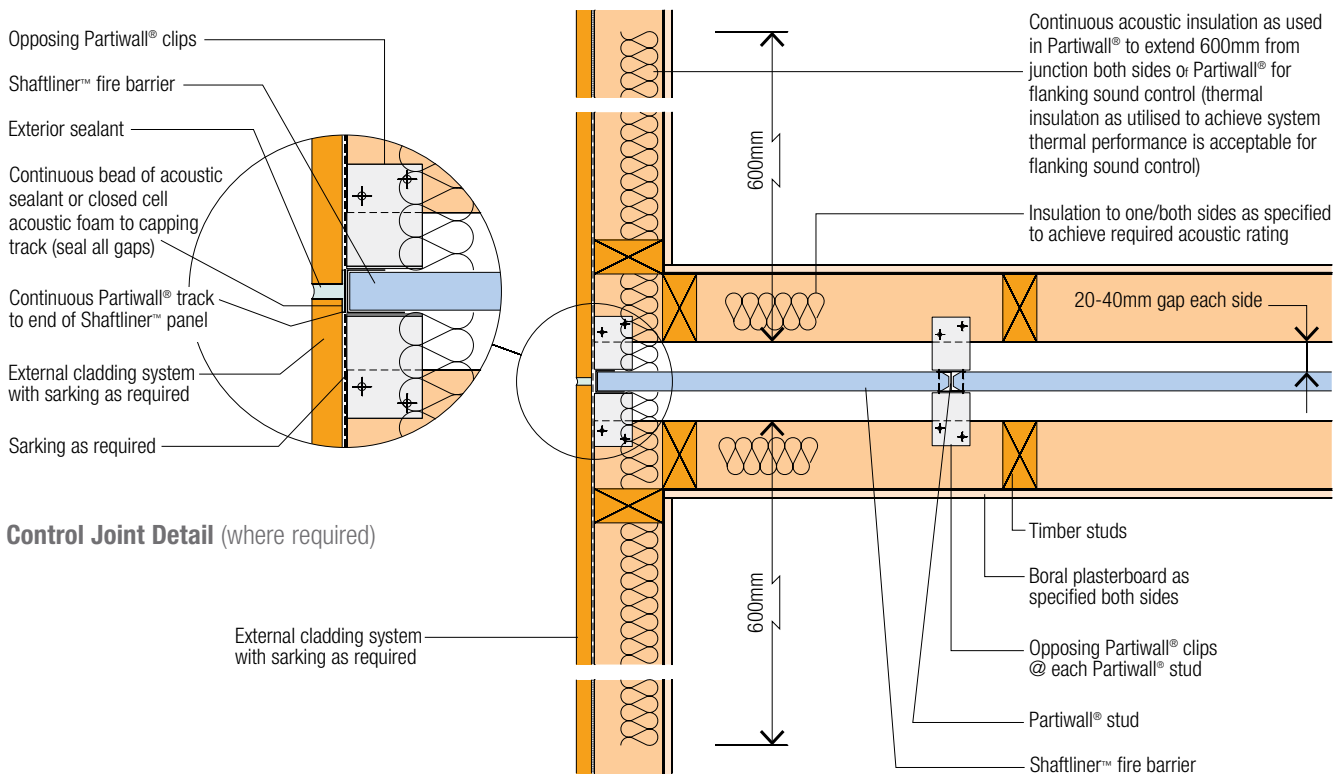

Control Joint Detail (where required)

Clad Wall - Junction Detail - FRL 60/60/60 (PW09)

» Details

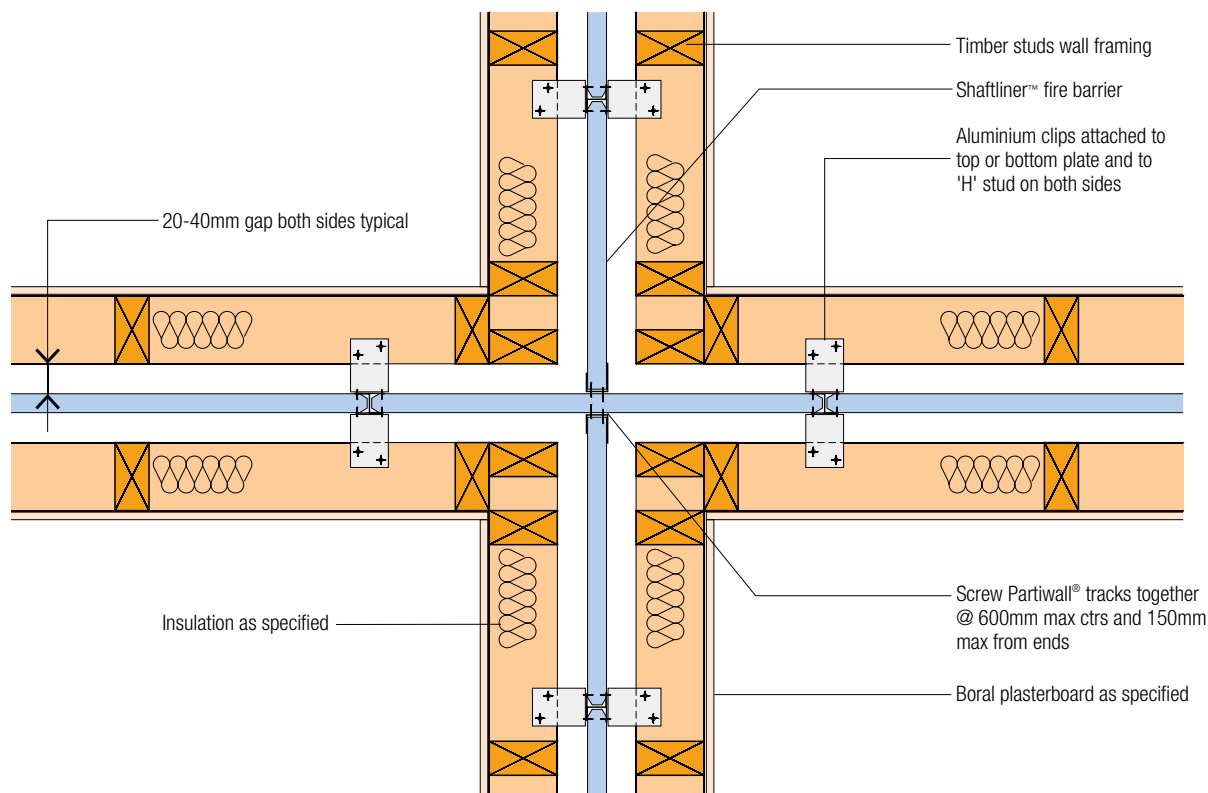

4-Way Intersecting Wall - Plan Detail - FRL 60/60/60 (PW11)

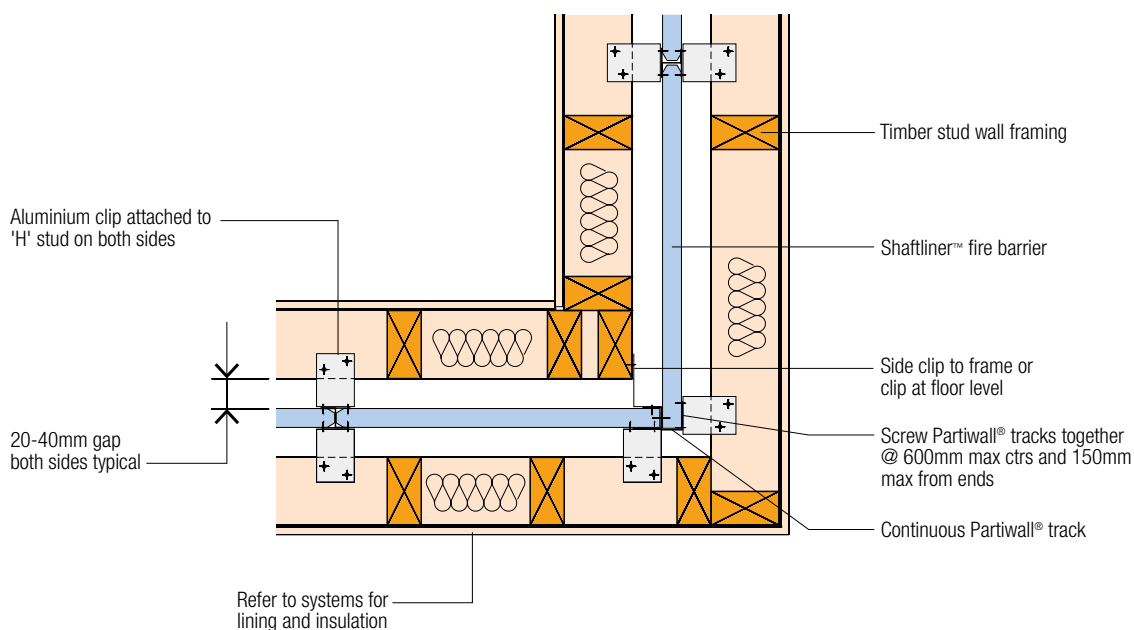

Typical Corner - Plan Detail - FRL 60/60/60 (PW10)

» Details

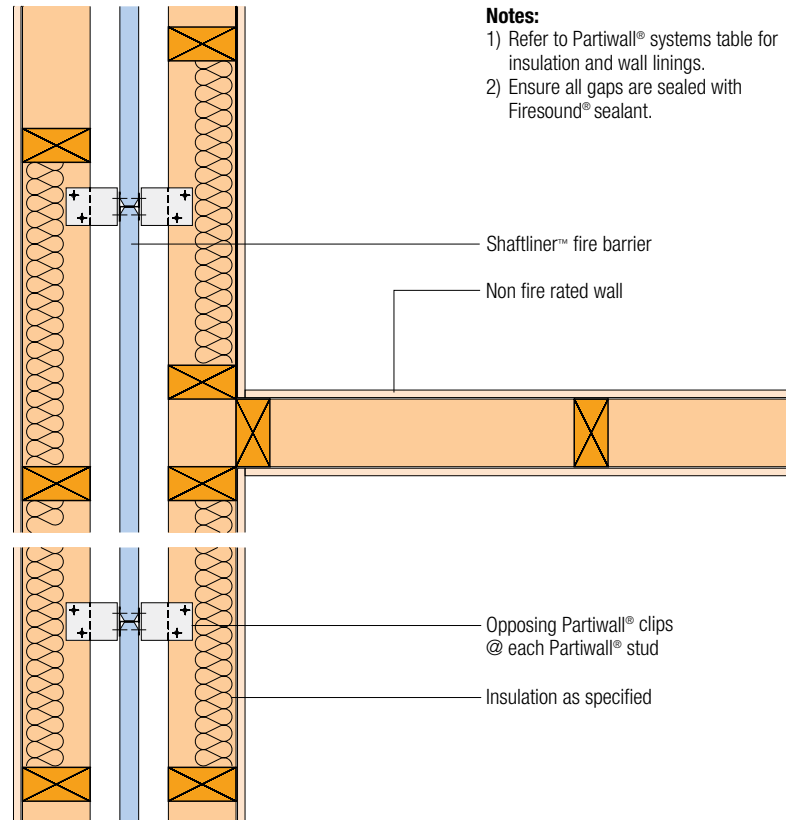

Internal Wall/Partiwall® Junction - FRL 60/60/60 (PW22)

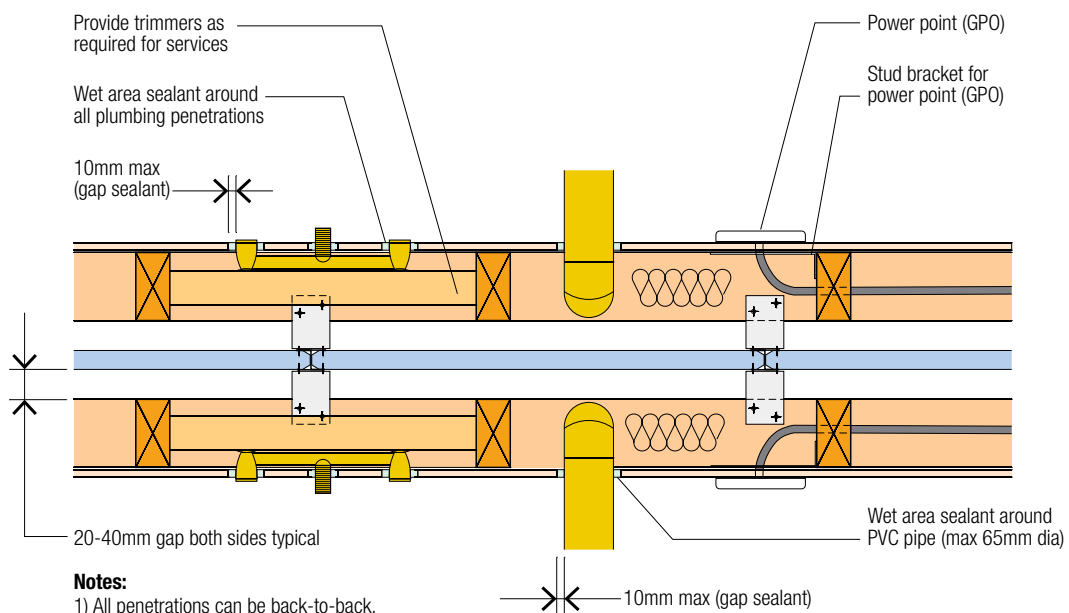

Wall Penetrations - Plan Details - FRL 60/60/60 (PW12)

» Details

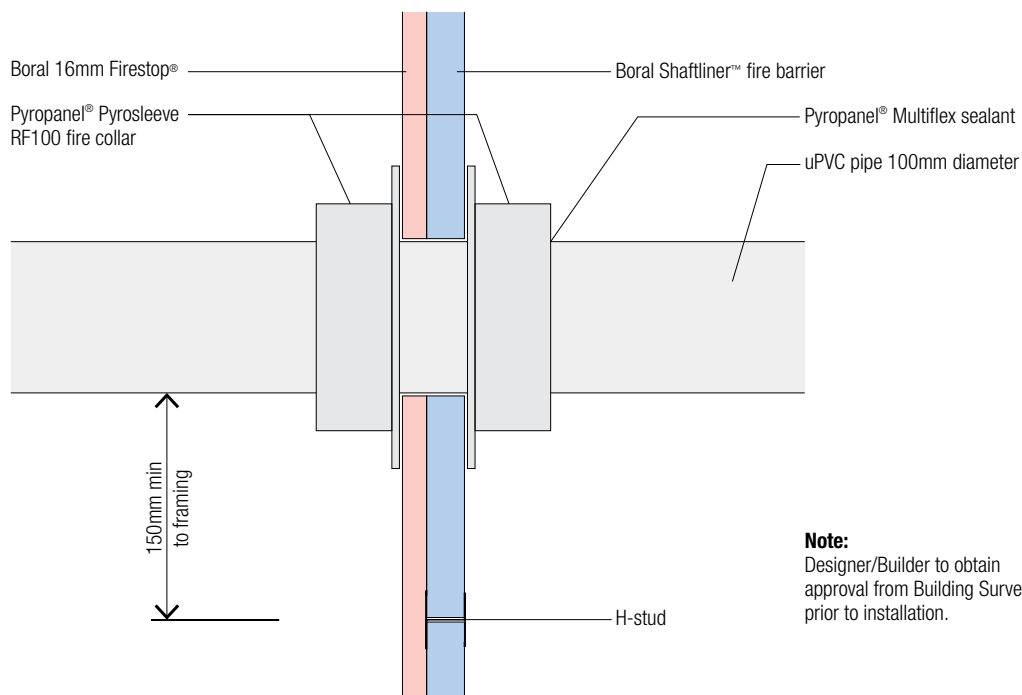

Note:
Designer/Builder to obtain approval from Building Surveyor prior to installation.

uPVC Pipe Penetration at Roof Space - FRL -/60/60 (PW19)

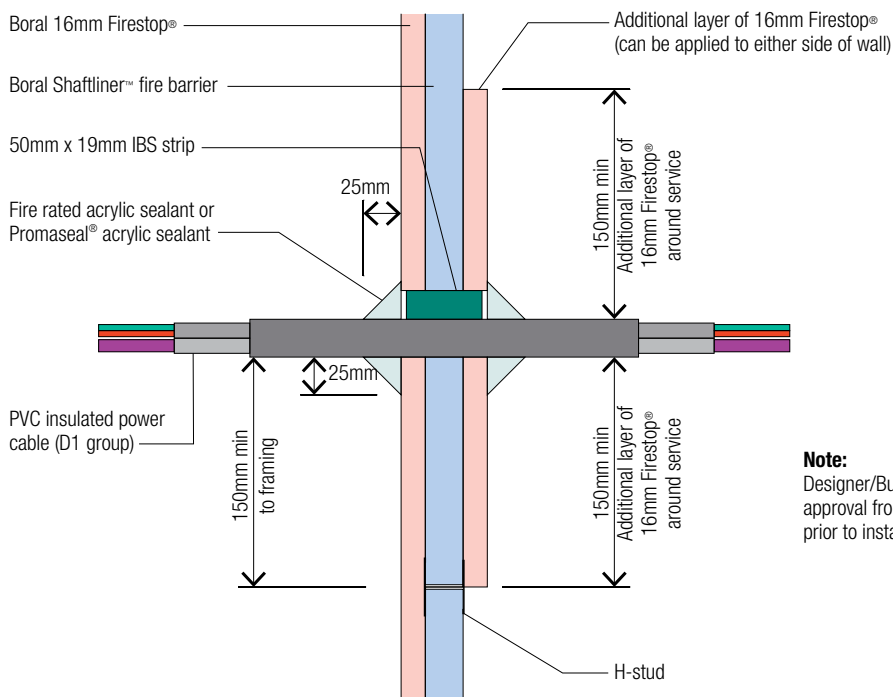

Note:
Designer/Builder to obtain approval from Building Surveyor prior to installation.

Power Cables Penetrations at Roof Space - FRL -/60/- (PW20)

» Details

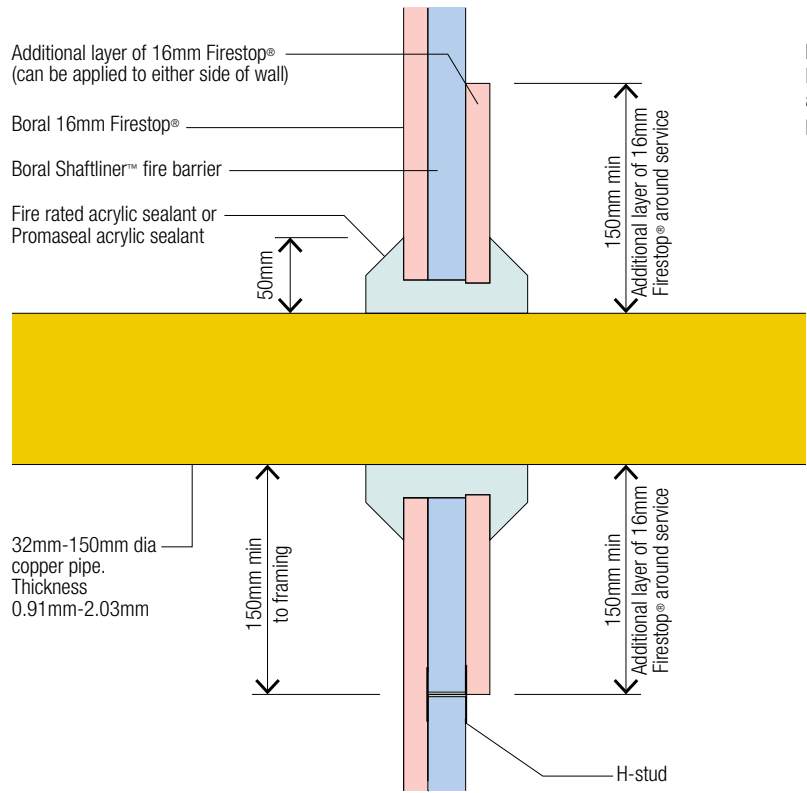

Note:
Designer/Builder to obtain approval from Building Surveyor prior to installation.

Copper Pipe Penetration at Roof Space - FRL -/60/- (PW21)

Installation of Shaftliner™ Fire Barrier

Installation of the Shaftliner™ fire barrier requires the attachment of the supporting Partiwall® studs to framing members using aluminium clips. Set out framing to allow for the required clearances on both sides of the Shaftliner™ fire barrier and later clipping of the Partiwall® studs to wall plates and roof trusses.

After the framing on one side has been completed, the Shaftliner™ fire barrier is installed and clipped to the completed side. When framing on the other side is completed the Shaftliner™ fire barrier is clipped to that side.

The sequence of construction should be planned to accommodate the progressive erection of the Shaftliner™ fire barrier.

Protection From Weather

To prevent damage from the weather all materials must be suitably protected during construction.

Boral recommends that exposure of the Shaftliner™ fire barrier to the elements should be minimised, and that protection is provided if exposure is likely to exceed one month or when periods of intense inclement weather, such as heavy rain or high winds, are expected. Allow it to dry out before lining the occupancy areas.

Temporary exposure of Shaftliner™ fire barrier to moisture should not downgrade its fire resisting properties as long as there is no physical damage to the panels in a wet state.

Boral also recommends that concrete slabs on which the Shaftliner™ fire barrier is erected should be level, free draining, and free of depressions where water can collect, removing the possibility of the panel standing in the water for any length of time. The specified 6mm gap between the adjacent bottom track lengths will facilitate drainage of water from the track.

Do's and Don'ts

- **Do** use aluminium clips at every Partiwall® stud and not more than 3000mm above lower clip line or base track.
- **Do** locate and fix down bottom track adequately.
- **Do** seal at bottom track.
- **Do** install Boral Firepack™ at wall ends and top, as specified.
- **Do** cut Partiwall® stud and Shaftliner™ panels to the same length.
- **Do** insert Partiwall® stud and Shaftliner™ fully into the base track.
- **Do** insert Shaftliner™ panels fully into the Partiwall® studs.
- **Do** use the specified fasteners for aluminium Partiwall® clips.
- **Don't** use damaged materials.
- **Don't** penetrate the Shaftliner™ other than in the roof space as per Boral's details.
- **Don't** exceed specified clip spacing.
- **Don't** use steel clips.
- **Don't** cut tracks between Partiwall® studs. Tracks should be used in full lengths.
- **Don't** run services in the gap between Shaftliner™ fire barrier and framework.
- **Don't** use Partiwall® H-stud in lieu of Partiwall® track as edge capping nor as horizontal joint in Shaftliner™ fire barrier.

» Installation of Shaftliner™ Fire Barrier

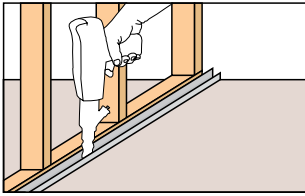

Step 1: Fixing bottom track

- Position track at the base level centred in the Partiwall® cavity and attach to foundation with power actuated fasteners at both ends and at 600mm maximum spacing.
- Use full lengths spaced 6mm apart and 20-40mm from the frame.
- Start and end nominal 40mm from inside of external brickwork or level with inside face of cladding material.
- Apply acoustic sealant along track/floor junction on one side. Refer to step 7.

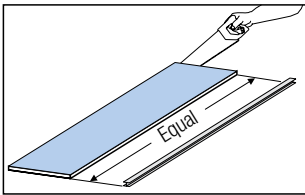

Step 2: Cut Shaftliner™ panels and Partiwall® stud to the same length

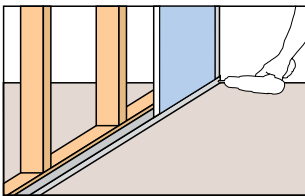

Step 3: First Shaftliner™ panel fitted into base track

- To enable later fixing of aluminium clips, cut this Shaftliner™ panel to width so that its edge falls at least 50mm from a wall frame stud.
- House the outside edge at the end of the wall with the track.
- Screw this end track to the base track where they meet.

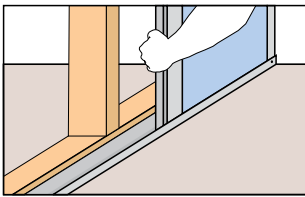

Step 4: First Partiwall® stud fits fully down into track

- Move it along the track to house the edge of the Shaftliner™.
- Lightly tap up to give a snug fit.
- Fit the second Shaftliner™ panel.
- Fix H-stud to timber frame with Partiwall® aluminium clip.

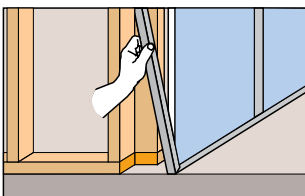

Step 5: Continue fitting Partiwall® studs and Shaftliner™ panels

- Continue to erect Partiwall® studs and Shaftliner™ panels progressively until the fire barrier is completed.
- House last Shaftliner™ panel with track at the end of the wall.
- Exposed Shaftliner™ barrier may be subjected to high wind forces and so must be adequately braced while exposed to the wind.

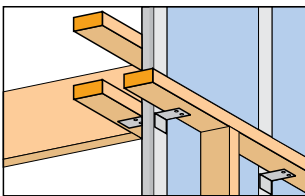

Step 6: Aluminium Partiwall® clips fasten all Partiwall® studs to wall frame

- Must be at every Partiwall® stud.
- Maximum 3000mm apart vertically.
- For aligned floors, must be directly opposite on both sides of the Partiwall® studs. Alternatively, Partiwall® clips can be staggered in line with offset floors.
- Where Shaftliner™ panels butt to external wall, cap the vertical edge of panels with Partiwall® track screw fixed to base track with 10g x 16mm drill point wafer head screws.

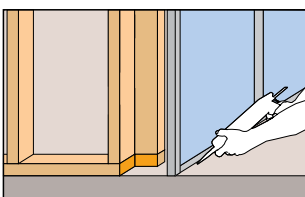

Step 7: Seal for acoustics and fire

- Install continuous Boral Firepack™ at wall ends and roof as specified.
- Seal bottom track with a recommended fire rated acoustic sealant.

» Installation of Shaftliner™ Fire Barrier

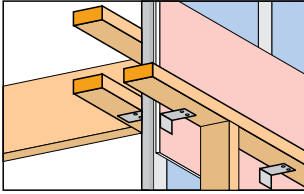

Step 8: At mid-floor

- Cut and screw laminate 16mm Firestop® plasterboard to one side ensuring minimum 150mm overlap above floor and below ceiling level.
- It is recommended the gap from Partiwall® panel to wall stud framing be increased to a minimum of 25mm on this side to ensure adequate clearance for the Firestop® plasterboard.
- Screw laminate one layer of 16mm Boral Firestop® plasterboard to one side of Shaftliner™ fire barrier as required. Fasten at maximum 400mm x 400mm centres with 10g x 40mm Type 'L' laminating screws minimum 10mm from edge of the board.
- Fix clips to Partiwall® studs with 2 x 10g x 16mm 'D' type screws.
- Fix clips to timber plates with 2 x 2mm dia x 25mm nails or 2 x 6g x 25mm 'W' type screws.
- Fix clips through 16mm Firestop® to Partiwall® studs with 2 x 10g x 30mm 'D' type screws.
- As framing progresses, clip Partiwall® studs to wall plates on the other side.

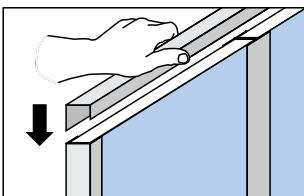

Step 9: Cap top of Shaftliner™ panels and Partiwall® studs with track

- Use full lengths, end to end, spaced 6mm apart.
- Houses top of Partiwall® studs, end tracks and Shaftliner™ panels.
- Screw this capping track to the end tracks where they meet.

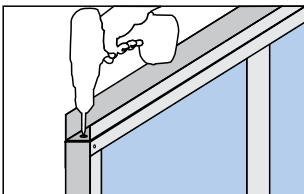

Step 10: Upper sections

- Back capping track with base track.
- Fasten with minimum 10g x 16mm screws at 600mm centres.
- Cut Shaftliner™ panels and Partiwall® studs, cut to a length not exceeding 600mm above clip support points.
- Install as previously Partiwall® studs to align vertically with bottom section.

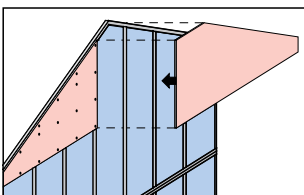

Step 11: At roof

- Measure and cut Shaftliner™ panels and Partiwall® studs to pitch of roof.
- Allow gap for frame shrinkage and roof movement in pitched roof application. Provide max 25mm gap between underside of flat metal roof/parapet/box gutter applications.
- Cap on rake and clip Partiwall® studs to roof frame on one side.
- Cut and screw laminate 16mm Firestop® plasterboard to one side of Shaftliner™ fire barrier in the roof space with 10g x 40mm Type 'L' laminating screws at 400mm x 400mm centres, minimum 10mm from edge of Firestop®.
- Fix Partiwall® clips to Partiwall® studs through 16mm Firestop® plasterboard with 10g x 30mm Type 'D' drill point screws and to framing.
- Provide nominal 25mm gap between top end of Shaftliner™ fire barrier and roofing.

Sustainability

Boral Plasterboard aims to minimise the environmental impact of its operations and to make a positive difference to the environment and communities in which it operates. Plasterboard is manufactured from abundant natural gypsum resources and 100% recycled paper liner.

Plasterboard waste can be recycled back into new plasterboard or used as a soil conditioner. Please contact Boral Plasterboard regarding waste collection services available in your region.

Health and Safety

For information regarding the safe use of Boral Plasterboard products and accessories please refer to instructions on the product packaging or contact your local Boral Plasterboard Sales Office or TecASSIST® for a current copy of the Material Safety Data Sheet.

Technical Enquiries 1800 811 222

TecASSIST® provides technical advice to builders, architects, contractors, engineers, regulators and home owners throughout Australia.

Our friendly team can offer both practical and design input at all levels of the plasterboard industry. Get your next project off on the right track by contacting TecASSIST® weekdays 8.30am - 4.30pm AEST on 1800 811 222 or www.boral.com.au/tecassist.

Sales Enquiries

1800 003 377

ACT	7 Barrier Street, Fyshwick 2609	F: (02) 6280 5816
New South Wales	3 Thackeray Street, Camellia 2142	F: (02) 9638 5557
Northern Territory	Coonawarra Road, Winnellie 0820	F: (08) 8984 3778
Queensland	22 Kirra Street, Pinkenba 4008	F: (07) 3115 7321
South Australia	39 Burleigh Avenue, Woodville North 5012	F: (08) 7002 6381
Tasmania	93 Albert Road, Moonah 7009	F: (03) 6278 9865
Victoria	251 Salmon Street, Port Melbourne 3207	F: (03) 9214 2192
Western Australia	41 Rudderham Drive, North Fremantle 6159	F: (08) 6226 9833
Export Department	251 Salmon Street, Port Melbourne 3207	F: (03) 9214 2192 T: (03) 9214 2121 E: tecexport@boral.com.au

www.boral.com.au/partiwall

Boral, the Boral Logo and [boral.com.au](http://www.boral.com.au), Firewall®, Partiwall®, IntRwall®, OutRwall®, Fireclad®, Cinemazone®, Firestop® and Linerstrip® are registered trade marks of Boral Australian Gypsum Ltd in Australia, other countries, or both. If these and other Boral trade marks are marked on their first appearance in this information with trade mark symbols (® or ™), these symbols indicate Australian registered or common law trade marks owned by Boral and others at the time this information was published. Such trade marks may also be registered or common law marks in other countries.

© Copyright Boral Limited 2013

This technical information is intended to provide general information on plasterboard products and should not be a substitute for professional building advice. We recommend you use a qualified person to install Boral plasterboard. Illustrations in this guide are only representative of Boral plasterboard products and the appearance and effects that may be achieved by their use. To ensure the information you are using is current, Boral recommends you review the latest building information available on the Boral website. For further information contact TecASSIST® or your nearest Boral Plasterboard Sales Office.

